

brother®

Operation Manual

- **1** GETTING READY
- **Read before use.** ● **2** SEWING BASICS
- **3** UTILITY STITCHES
- **Read when additional information is required.** ● **4** APPENDIX

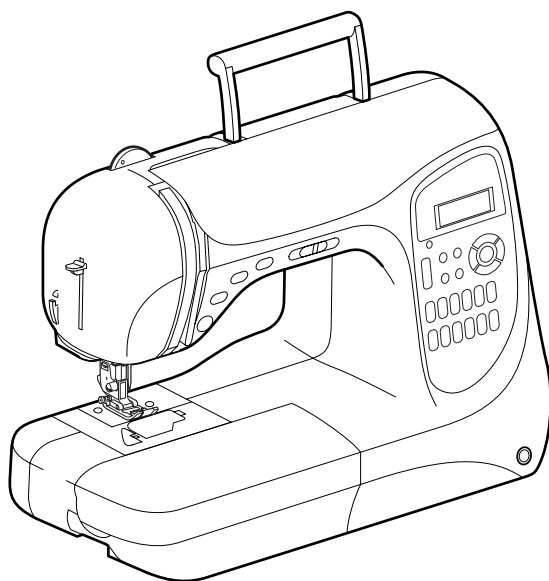

*Computerized Sewing Machine*  
**Operation Manual**

## Enclosed Accessories

After opening the box, check that the following accessories are enclosed. If any item is missing or damaged, contact your retailer.

### Accessories

The following items should also be enclosed in the box.

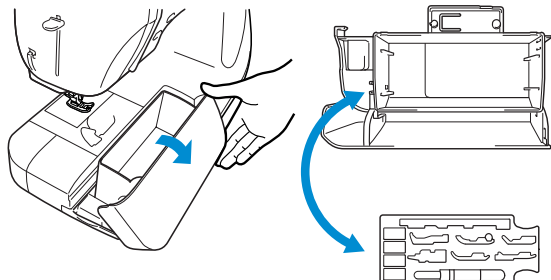

#### Note

(For U.S.A. only)

- Foot controller: Model N5V  
This foot controller can be used on this machine model NX-400/PC-420.
- The screw of the presser foot holder is available through your authorized dealer (Part code: XA4813-051).
- The organized accessory tray is available through your authorized dealer. (Part code: XC4489-051)

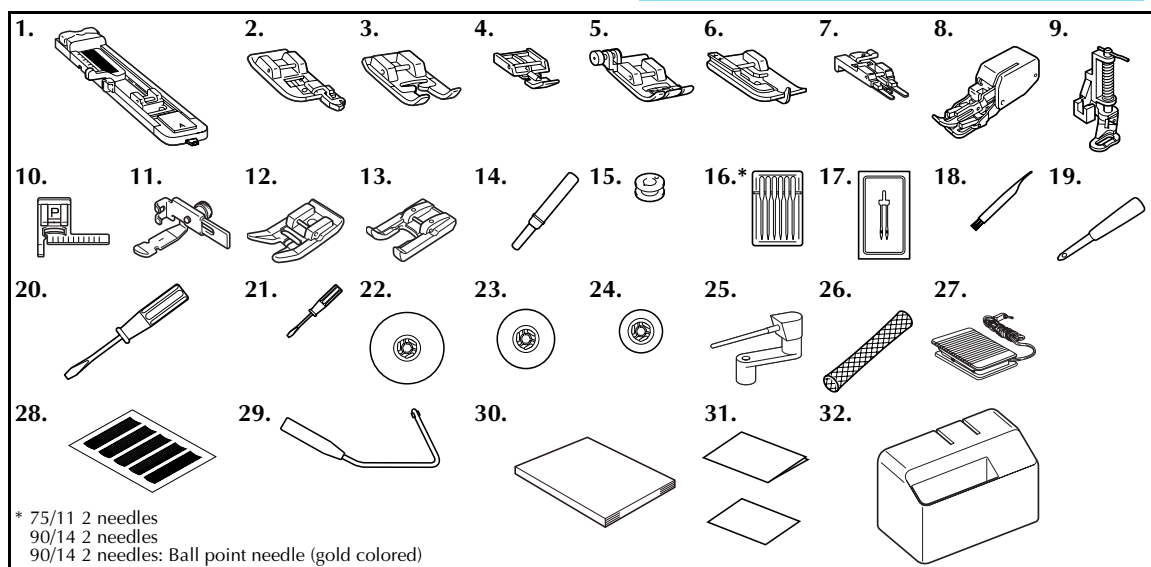

No.	Part Name	Part Code		No.	Part Name	Part Code	
		U.S.A.	Others			U.S.A.	Others
1	Buttonhole foot "A"	XC2691-051		17	Twin needle	X59296-051	
2	Overcasting foot "G"	XC3098-051		18	Cleaning brush	X59476-051	
3	Monogramming foot "N"	X53840-351		19	Eyelet punch	135793-001	
4	Zipper foot "I"	X59370-051		20	Screwdriver (large)	X55467-051	
5	Zigzag foot "J" (on machine)	XC3021-051		21	Screwdriver (small)	X55468-051	
6	Blind stitch foot "R"	X56409-051		22	Spool cap (large)	130012-054	
7	Button fitting foot "M"	130489-001		23	Spool cap (medium)(2)	X55260-153	
8	Walking foot	SA140	XC2214-002	24	Spool cap (small)	130013-154	
9	Quilting foot	SA129	XC1948-002	25	Extra spool pin	XC4654-051	
10	Stitch guide foot "P"	SA160	XA8839-002	26	Spool net	XA5523-050	
11	Adjustable zipper/piping foot	SA161	XC1970-002	27	Foot controller	XC1154-051	
12	Non stick foot	SA114	XC1949-002	28	Grid sheet set	SA527	XC4549-051
13	Open toe foot	SA147	XC1964-002	29	Knee lifter	XA6941-052	
14	Seam ripper	X54243-001		30	Operation manual	XE1139-001	
15	Bobbin (4)	SA156	XA5539-151	31	Quick reference guide	XC4546-151, XC4589-051	
16	Needle set	X58358-051		32	Hard case	XC2360-152	

# Names of Machine Parts and Their Functions

The names of the various parts of the sewing machine and their functions are described below. Before using the sewing machine, carefully read these descriptions to learn the names of the machine parts.

## Front view

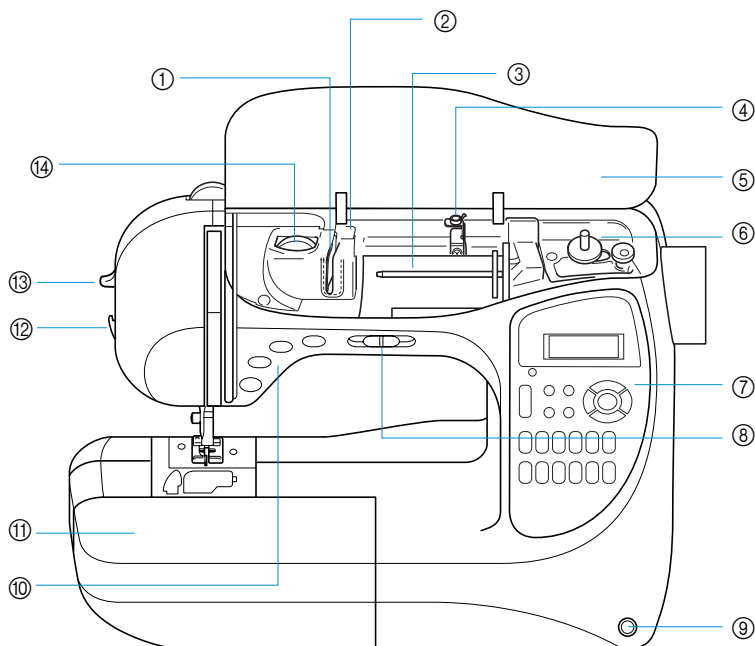

- ① **Thread guide plate / ② Thread guide cover**  
Pass the thread around the thread guide plate when threading the upper thread.
- ③ **Spool pin**  
Place the spool on the spool pin.
- ④ **Thread guide for bobbin winding**  
Pass the thread around this thread guide when winding the bobbin thread.
- ⑤ **Upper cover**  
Open the upper cover to place the spool of thread on the spool pin.
- ⑥ **Bobbin winder**  
Use the bobbin winder when winding the bobbin.
- ⑦ **Operation panel**  
Select a stitch from those that appear in the operation panel. (page Cover E)
- ⑧ **Sewing speed controller**  
Use the sewing speed controller to adjust the sewing speed.

- ⑨ **Knee lifter mounting slot**  
Plug the knee lifter into the knee lifter mounting slot.
- ⑩ **Operation buttons**  
Use the operation buttons to start the sewing machine and automatically cut the thread. (page Cover D)
- ⑪ **Flat bed attachment with accessory compartment**  
Store presser feet and bobbins in the accessory compartment of the flat bed attachment. When sewing cylindrical pieces, remove the flat bed attachment.
- ⑫ **Thread cutter**  
Pass the threads through the thread cutter to cut them.
- ⑬ **Needle threader lever**  
Use the needle threader to thread the needle.
- ⑭ **Thread tension dial**  
Use the thread tension dial to adjust the tension of the upper thread.

## Needle and presser foot section

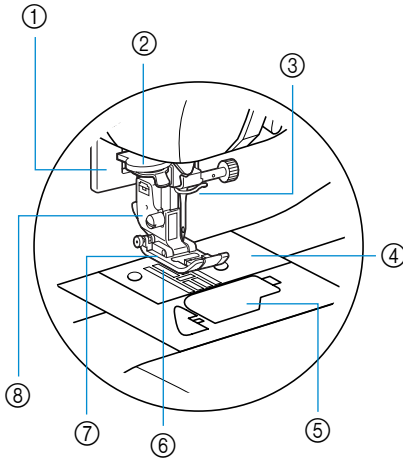

- ① **Buttonhole lever**  
Lower the buttonhole lever when sewing buttonholes and bar tacks.
- ② **Thread guide discs**  
Pass the thread through the thread guide discs when using the needle threader to thread the needle.
- ③ **Needle bar thread hook**  
Pass the upper thread through the needle bar thread hook.
- ④ **Needle plate**  
The needle plate is marked with guides for sewing straight seams.
- ⑤ **Bobbin cover/shuttle**  
Remove the bobbin cover, and then insert the bobbin into the shuttle.
- ⑥ **Feed dogs**  
The feed dogs feed the fabric in the sewing direction.
- ⑦ **Presser foot**  
The presser foot applies pressure consistently on the fabric as the sewing takes place. Attach the appropriate presser foot for the selected stitching.
- ⑧ **Presser foot holder**  
The presser foot is installed onto the presser foot holder.

## Right-side/rear view

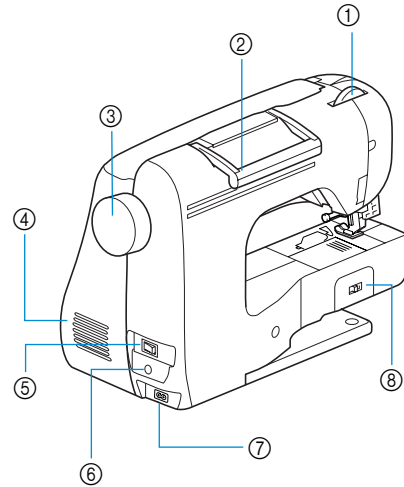

- ① **Presser foot dial**  
Use the presser foot dial to adjust the amount of pressure that the presser foot applies to the fabric.
- ② **Handle**  
Carry the sewing machine by its handle when transporting the machine.
- ③ **Balance wheel**  
Turn the balance wheel toward you to raise and lower the needle to sew one stitch.
- ④ **Air vent**  
The air vent allows the air surrounding the motor to be exchanged. Do not cover the air vent while the sewing machine is being used.
- ⑤ **Main power switch**  
Use the main power switch to turn the sewing machine on and off.
- ⑥ **Foot controller jack**  
Insert the plug on the end of the foot controller cable into the foot controller jack.
- ⑦ **Power supply jack**  
Insert the plug on the power supply cord into the power supply jack.
- ⑧ **Feed dog position switch**  
Use the feed dog position switch to lower the feed dogs.

### Memo

- Refer to Cover B, D or E pages while you are learning to use your machine.

## Operation buttons

The operation buttons help you to easily perform various basic sewing machine operations.

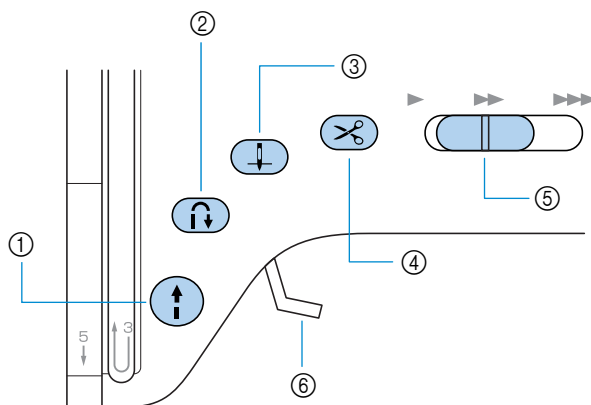

### ① Start/stop button

Press the start/stop button to start or stop sewing. The machine sews at a slow speed at the beginning of sewing while the button is depressed. When sewing is stopped, the needle is lowered in the fabric. For details, refer to “Starting to sew” (page 49).

The button lights up in green, red or orange, depending on how the sewing machine is being operated.

Green: When the machine is ready to start sewing or while it is sewing

Red: When the machine is not ready to start sewing

Orange: When the bobbin winder shaft is moved to the right for winding the bobbin thread onto the bobbin

### ② Reverse/reinforcement stitch button

Press the reverse/reinforcement stitch button to sew reverse stitches or reinforcement stitches. Reverse stitches are sewn by keeping the button pressed down to sew in the opposite direction. Reinforcement stitches are sewn by sewing 3 to 5 stitches on top of each other. For details, refer to “Securing the stitching” (page 51).

### ③ Needle position button

Press the needle position button to raise or lower the needle. Pressing the button twice sews one stitch.

### ④ Thread cutter button

Press the thread cutter button after stopping sewing to cut both the upper and the bobbin threads. For details, refer to “Cutting the thread” (page 53).

### ⑤ Sewing speed controller

Slide the sewing speed controller to adjust the sewing speed.

### ⑥ Presser foot lever

Raise and lower the presser foot lever to raise and lower the presser foot.

## CAUTION

- Do not press the thread cutter button after the threads have already been cut, otherwise the needle may break, the threads may become tangled or damage to the machine may occur.

## Note

- Do not press the thread cutter button if there is no fabric under the presser foot or while the machine is sewing, otherwise damage to the machine may occur.
- When cutting thread thicker than #30, nylon thread or other special threads, use the thread cutter on the side of the machine. For details, refer to “Cutting the thread” (page 53).

## Operation panel

The operation panel, located on the front at the right of the sewing machine, consists of the LCD (liquid crystal display) and keys for specifying various sewing settings.

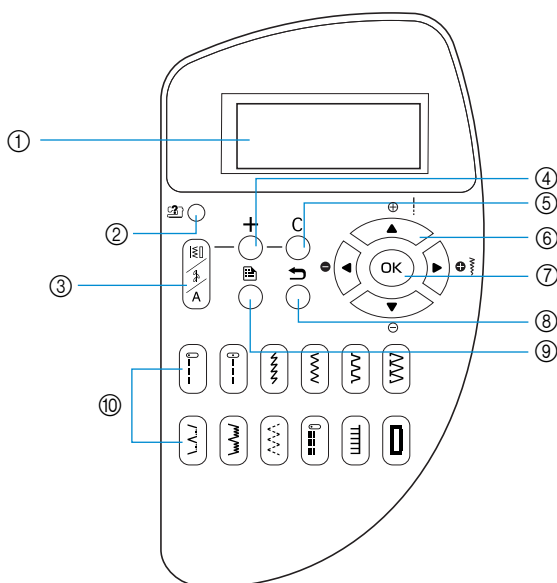

### ① LCD (liquid crystal display)

Settings for the selected stitch and error messages for incorrect operations appear in the LCD. Use keys ② through ⑩, described below, to display various items and select the settings. For details, refer to “Understanding the LCD Screens” (page 12).

### ② Sewing machine help key

Press this key to display operation information. Simple descriptions on threading the upper thread, installing the bobbin, winding the bobbin and replacing the presser foot can be displayed.



### ③ Stitch selection key

Press this key to select the desired type of stitch.

### ④ + key





Press this key to add a pattern when sewing combinations of characters or decorative stitches.

### ⑤ C key

Press this key to remove an added pattern when sewing combinations of characters or decorative stitches.



### ⑥ Arrow keys

Use these keys to move in the indicated direction when selecting an item displayed on the screen. In addition,   can be pressed to select a lower setting and   can be pressed to select a higher setting.

### ⑦ OK key

Press this key to apply the selected item.

### ⑧ Back key

Press this key to return to the previous screen.

### ⑨ Settings key

Press this key to select sewing settings, such as for automatic reverse/reinforcement stitching, or other settings such as the operation beep.

### ⑩ Stitch keys

Use these keys to quickly select one of 12 of the most often used stitches. For details, refer to “Selecting stitching” (page 68).

## Optional Accessories

The following are available as optional accessories.

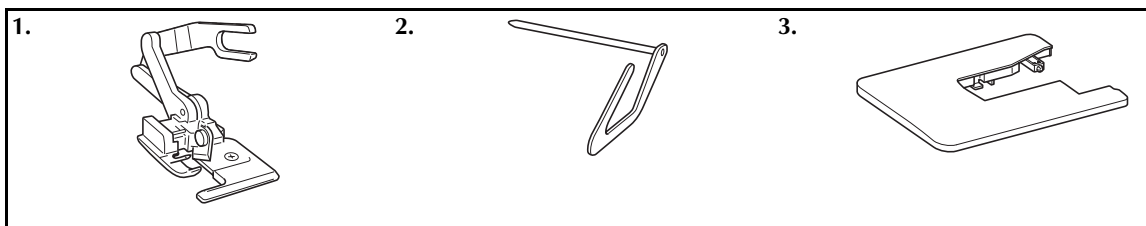

**1. Side cutter**

Part code: SA177,XC3879-002

**2. Quilting guide**

Part code: SA132, XC2215-002

**3. Wide table**

Part code: SA537,XC4541-051



### Memo

- To obtain optional accessories or parts, contact your sales representative or the nearest authorized service center.

## Introduction

Thank you for purchasing this sewing machine.

Before using this sewing machine, carefully read the “Important Safety Instructions” (page 6), and then study this manual for the correct operation of the various functions.

In addition, after you have finished reading this manual, store it where it can quickly be accessed for future reference.

## Sewing Machine Features

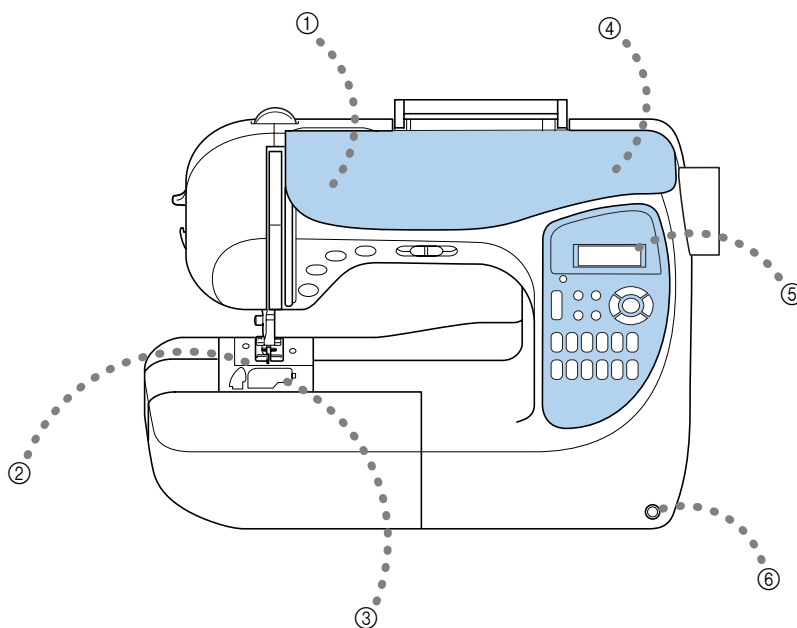

- ① **Easy upper threading**  
Since the spool can be installed at the front of the sewing machine, the upper thread can easily be threaded. In addition, the needle can be threaded with a simple operation. (page 24)
- ② **Automatic thread-cutting**  
The sewing machine can be set to automatically cut the thread at the end of the stitching. (page 58)
- ③ **One-touch lower threading**  
You can start sewing without pulling up the bobbin thread. (page 22)
- ④ **Simple bobbin-winding**  
The bobbin can quickly and easily be wound with thread. (page 18)
- ⑤ **Built-in stitches**  
You can select from the built-in stitches available, including utility stitches, character stitches and decorative stitches. Twelve of the most often used utility stitches can quickly be selected with the stitch keys. (page 68)
- ⑥ **Knee lifter**  
Use the knee lifter to raise and lower the presser foot with your knee, leaving both hands free to handle the fabric. (page 61)



# Contents

<b>Enclosed Accessories</b> .....	<b>Cover A</b>
Accessories .....	Cover A
<b>Names of Machine Parts and Their Functions</b> .....	<b>Cover B</b>
Front view .....	Cover B
Needle and presser foot section .....	Cover C
Right-side/rear view .....	Cover C
Operation buttons .....	Cover D
Operation panel .....	Cover E
<b>Optional Accessories</b> .....	<b>1</b>
<b>Introduction</b> .....	<b>2</b>
<b>Sewing Machine Features</b> .....	<b>2</b>
<b>Contents</b> .....	<b>3</b>
<b>Important Safety Instructions</b> .....	<b>6</b>

## GETTING READY ..... 9

<b>Turning the Machine On/Off</b> .....	<b>10</b>
Power supply precautions .....	10
Turning on the machine .....	11
Turning off the machine .....	11
<b>Understanding the LCD Screens</b> .....	<b>12</b>
Checking machine operating procedures .....	13
<b>Changing the Machine Settings</b> .....	<b>14</b>
Changing the settings .....	14
Changing the needle stop position .....	16
Adjusting the brightness of the LCD .....	16
Changing the screen language .....	17
<b>Winding/Installing the Bobbin</b> .....	<b>18</b>
Bobbin precautions .....	18
Winding the bobbin .....	18
Installing the bobbin .....	22
<b>Upper Threading</b> .....	<b>24</b>
Threading the upper thread .....	24
Threading the needle .....	27
Using the twin needle .....	28
Using thread that winds off quickly .....	31
Pulling up the bobbin thread .....	31
<b>Replacing the Needle</b> .....	<b>33</b>
Needle precautions .....	33
Needle types and their uses .....	33
Checking the needle .....	34
Replacing the needle .....	35
<b>Replacing the Presser Foot</b> .....	<b>37</b>
Presser foot precautions .....	37
Replacing the presser foot .....	37
Adjusting the pressure of the presser foot .....	39
Removing the presser foot holder .....	39
Using the walking foot .....	40
<b>Sewing Cylindrical or Large Pieces</b> .....	<b>42</b>
Stitching cylindrical pieces .....	42
Sewing large pieces of fabric .....	42

<b>SEWING BASICS</b> .....	<b>45</b>
<b>Sewing</b> .....	<b>46</b>
General sewing procedure .....	47
Positioning the fabric .....	48
Starting to sew .....	49
Securing the stitching .....	51
Cutting the thread .....	53
<b>Adjusting the Thread Tension</b> .....	<b>54</b>
Changing the tension of the upper thread .....	54
<b>Adjusting the Stitch Width and Length</b> .....	<b>55</b>
Adjusting the stitch width .....	55
Adjusting the stitch length .....	56
<b>Useful Functions</b> .....	<b>57</b>
Automatically sewing reverse/reinforcement stitches .....	57
Automatically cutting the thread .....	58
Saving stitch settings .....	60
Hands-free raising and lifting of the presser foot .....	61
<b>Useful Sewing Tips</b> .....	<b>62</b>
Trial sewing .....	62
Changing the sewing direction .....	62
Sewing curves .....	62
Sewing thick fabrics .....	63
Sewing thin fabrics .....	64
Sewing stretch fabrics .....	64
Sewing leathers or vinyl fabrics .....	64
Sewing an even seam allowance .....	64
<b>UTILITY STITCHES</b> .....	<b>67</b>
<b>Selecting Stitching</b> .....	<b>68</b>
Stitch types .....	68
Selecting stitching .....	68
<b>Overcasting Stitches</b> .....	<b>70</b>
Sewing overcasting stitches using overcasting foot “G” .....	70
Sewing overcasting stitches using zigzag foot “J” .....	71
Sewing overcasting stitches using the optional side cutter .....	72
<b>Basic Stitching</b> .....	<b>74</b>
Basting .....	74
Basic stitching .....	74
<b>Blind Hem Stitching</b> .....	<b>76</b>
<b>Buttonhole Stitching</b> .....	<b>78</b>
Buttonhole sewing .....	79
Button sewing .....	82
<b>Zipper Insertion</b> .....	<b>85</b>
Inserting a centered zipper .....	85
Inserting a side zipper .....	86
<b>Zipper/piping Insertion</b> .....	<b>89</b>
Inserting a centered zipper .....	89
Inserting a piping .....	90
<b>Sewing Stretch Fabrics and Elastic Tape</b> .....	<b>91</b>
Stretch stitching .....	91
Elastic attaching .....	91
<b>Appliqué, Patchwork and Quilt Stitching</b> .....	<b>93</b>
Appliqué stitching .....	93
Patchwork (crazy quilt) stitching .....	95
Piecing .....	95
Quilting .....	96
Free-motion quilting .....	97
Satin stitching .....	99

<b>Reinforcement Stitching</b> .....	<b>100</b>
Triple stretch stitching .....	100
Bar tack stitching .....	100
Darning .....	102
<b>Eyelet Stitching</b> .....	<b>104</b>
<b>Decorative Stitching</b> .....	<b>105</b>
Fagoting .....	106
Scallop stitching .....	107
Smocking .....	107
Shell tuck stitching .....	108
Joining .....	109
Heirloom stitching .....	110
<b>Sewing the Various Built-In Decorative Patterns</b> .....	<b>113</b>
Sewing beautiful patterns .....	113
Sewing patterns .....	113
Combining patterns .....	114
Repeat sewing patterns .....	115
Checking the selected pattern .....	116
Changing the pattern size .....	117
Changing the stitch density .....	118
Changing the pattern length .....	118
Mirror imaging the pattern .....	119
Storing a pattern .....	120
Realigning the pattern .....	121
<b>Designing a Pattern</b> .....	<b>123</b>
Drawing a sketch of the pattern .....	123
Entering the pattern data .....	124
Design exempld .....	126
<b>APPENDIX</b> .....	<b>127</b>
<b>Stitch Settings</b> .....	<b>128</b>
Utility stitches .....	128
Other stitches .....	133
<b>Maintenance</b> .....	<b>135</b>
Cleaning the machine surface .....	135
Cleaning the shuttle .....	135
<b>Troubleshooting</b> .....	<b>137</b>
Error messages .....	141
Nothing appears in the LCD .....	142
Operation beep .....	142
Cancelling the operation beep .....	143
Removing the upper cover .....	143
<b>Index</b> .....	<b>144</b>

## Important Safety Instructions

When using this machine, basic safety precautions should always be taken, including the following:

Read all instructions before using.

**DANGER** - To reduce the risk of electric shock:

1. The machine should never be left unattended while plugged in. Always unplug the machine from the electrical outlet immediately after using and before cleaning.

**WARNING** - To reduce the risk of burns, fire, electric shock, or injury to persons:

1. Do not allow this machine to be used as a toy. Close attention is necessary when the machine is used by or near children.
2. Use this machine only for its intended use as described in this manual. Use only accessories recommended by the manufacturer as contained in this manual.
3. Never operate this machine if it has a damaged cord or plug, if it is not working properly, if it has been dropped or damaged, or dropped into water. Return the machine to the nearest authorized dealer or service center for examination, repair, electrical or mechanical adjustment.
4. Never operate the machine with any air openings blocked. Keep ventilation openings of the machine and foot control free from the accumulation of lint, dust, and loose cloth.
5. Never drop or insert any object into any opening.
6. Do not use outdoors.
7. Do not operate where aerosol (spray) products are being used or where oxygen is being administered.
8. To disconnect, turn the main switch to the symbol "O" position which represents off, then remove plug from outlet.
9. Do not unplug by pulling on cord. To unplug, grasp the plug, not the cord.
10. Keep fingers away from all moving parts. Special care is required around the machine needle.
11. Always use the proper needle plate. The wrong plate can cause the needle to break.
12. Do not use bent needles.
13. Do not pull or push fabric while stitching. It may deflect the needle causing it to break.
14. Switch the machine to the symbol "O" position when making any adjustments in the needle area, such as threading needle, changing needle, threading bobbin, or changing presser foot, and the like.
15. Always unplug the machine from the electrical outlet when removing covers, lubricating, or when making any other user servicing adjustments mentioned in the instruction manual.
16. This sewing machine is not intended for use by young children or infirm persons without supervision.
17. Young children should be supervised to ensure that they do not play with this machine.
18. If the Light unit is damaged, it must be replaced by authorized dealer.

**SAVE THESE INSTRUCTIONS**  
**This machine is intended for household use.**

## FOR USERS IN THE UK, EIRE, MALTA AND CYPRUS ONLY

If this machine is fitted with a three-pin non-rewireable BS plug then please read the following.

### IMPORTANT

If the available socket outlet is not suitable for the plug supplied with this equipment, it should be cut off and an appropriate three-pin plug fitted. With alternative plugs an approved fuse must be fitted in the plug.

### NOTE

The plug served from the main lead must be destroyed as a plug with bared flexible cords is hazardous if engaged in a live socket outlet. In the event of replacing the plug fuse, use a fuse approved by ASTA to BS 1362, i.e. carrying the  mark, rating as marked on plug. Always replace the fuse cover, never use plugs with the fuse cover omitted.

### WARNING

**DO NOT CONNECT EITHER WIRE TO THE EARTH TERMINAL WHICH IS MARKED WITH THE LETTER 'E', BY THE EARTH SYMBOL  OR COLOURED GREEN OR GREEN AND YELLOW.**

The wires in this main lead are colored in accordance with the following code:

Blue	Neutral
Brown	Live

As the colors of the wiring in the main lead of this appliance may not correspond with the colored markings identifying the terminals in your plug, proceed as follows.

The wire which is colored blue must be connected to the terminal which is marked with the letter 'N' or colored black or blue.

The wire which is colored brown must be connected to the terminal which is marked with the letter 'L' or colored red or brown.

## CONGRATULATIONS ON CHOOSING OUR MACHINE

Your machine is one of the most advanced computerized household sewing machines. To fully enjoy all the features, we suggest that you study the manual before using the machine.

### PLEASE READ BEFORE USING THIS MACHINE

#### For safe operation

1. Be sure to keep your eye on the needle while sewing. Do not touch the hand wheel, thread take-up lever, needle, or other moving parts.
2. Remember to turn off the power switch and unplug the cord when:
  - Operation is completed
  - Replacing or removing the needle or any other parts
  - A power failure occurs during use
  - Maintaining the machine
  - Leaving the machine unattended
3. Do not store anything on the foot controller.
4. Plug the machine directly into the wall. Do not use extension cords.

#### For a longer service life

1. When storing this machine, avoid direct sunlight and high humidity locations. Do not use or store the machine near a space heater, iron, halogen lamp, or other hot objects.
2. Use only neutral soaps or detergents to clean the case. Benzene, thinner, and scouring powders can damage the case and machine, and should never be used.
3. Do not drop or hit the machine.
4. Always consult the operation manual when replacing or installing any assemblies, the presser feet, needle, or other parts to assure correct installation.

#### For repair or adjustment

In the event a malfunction occurs or adjustment is required, first follow the troubleshooting table in the back of the operation manual to inspect and adjust the machine yourself. If the problem persists, please consult your local authorized Brother dealer.

**For additional product information and updates, visit our web site at [www.brother.com](http://www.brother.com)**

## 1

**GETTING READY**

The various preparations required before starting to sew are described in this chapter.

<b>Turning the Machine On/Off .....</b>	<b>10</b>
<b>Understanding the LCD Screens .....</b>	<b>12</b>
<b>Changing the Machine Settings .....</b>	<b>14</b>
<b>Winding/Installing the Bobbin .....</b>	<b>18</b>
<b>Upper Threading .....</b>	<b>24</b>
<b>Replacing the Needle .....</b>	<b>33</b>
<b>Replacing the Presser Foot .....</b>	<b>37</b>
<b>Sewing Cylindrical or Large Pieces .....</b>	<b>42</b>

## Turning the Machine On/Off

This section explains how to turn the sewing machine on and off.

### Power supply precautions

Be sure to observe the following precautions concerning the power supply.

#### WARNING

- Use only regular household electricity for the power source. Using other power sources may result in fire, electric shock, or damage to the machine.
- Turn off the main power and remove the plug in the following circumstances:
  - When you are away from the machine
  - After using the machine
  - When the power fails during use
  - When the machine does not operate correctly due to a bad connection or a disconnection
  - During electrical storms

#### CAUTION

- Do not use extension cords or multi-plug adapters with many other appliances plugged in to them. Fire or electric shock may result.
- Do not touch the plug with wet hands. Electric shock may result.
- When unplugging the machine, always turn off the main power first. Always grasp the plug to remove it from the outlet. Pulling on the cord may damage the cord, or lead to fire or electric shock.
- Do not allow the power cord to be cut, damaged, modified, forcefully bent, pulled, twisted, or bundled. Do not place heavy objects on the cord. Do not subject the cord to heat. These things may damage the cord and cause fire or electric shock. If the cord or plug is damaged, take the machine to your authorized dealer for repairs before continuing use.
- Unplug the power cord if the machine is not to be used for a long period of time. Otherwise a fire may result.



## Turning on the machine

- 1 Make sure that the sewing machine is turned off (the main power switch is set to "O"), and then plug the power supply cord into the power supply jack on the right side of the machine.
- 2 Insert the plug of the power supply cord into a household electrical outlet.

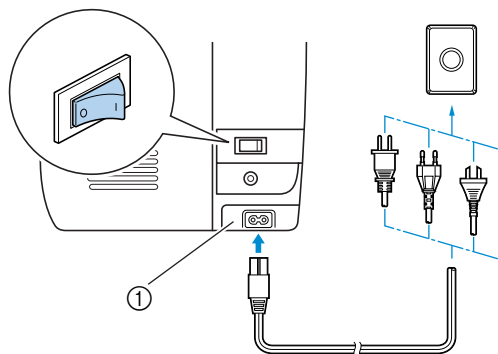

① Power supply jack

- 3 Press the right side of the main power switch on the right side of the machine (set it to "I").

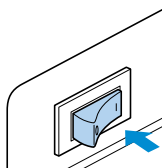

- ▶ The sewing lamp and the LCD come on when the machine is turned on.

## Turning off the machine

When you are finished using the sewing machine, turn it off. In addition, before transporting the sewing machine to another location, be sure to turn it off.

- 1 Make sure that the machine is not sewing.
- 2 Press the left side of the main power switch on the right side of the machine (set it to "O").

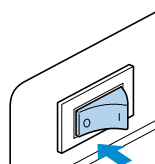

- ▶ The sewing lamp goes off when the machine is turned off.

- 3 Unplug the power supply cord from the electrical outlet.  
Grasp the plug when unplugging the power supply cord.
- 4 Unplug the power supply cord from the power supply jack.

### Note

- When the sewing machine is turned off, all stitch settings are cancelled.
- If a power outage occurs while the sewing machine is being operated, turn off the sewing machine and unplug the power supply cord. When restarting the sewing machine, follow the necessary procedure to correctly operate the machine.

(For U.S.A. only)

- This appliance has a polarized plug (one blade wider than the other). To reduce the risk of electrical shock, this plug is intended to fit in a polarized outlet only one way. If the plug does not fit fully in the outlet, reverse the plug. If it still does not fit, contact a qualified electrician to install the proper outlet. Do not modify the plug in any way.

## Understanding the LCD Screens

The LCD screen, located on the front at the right of the sewing machine, displays the settings for the selected stitch and error messages if operations are performed incorrectly. When the sewing machine is turned on, the LCD comes on and the following screen appears.

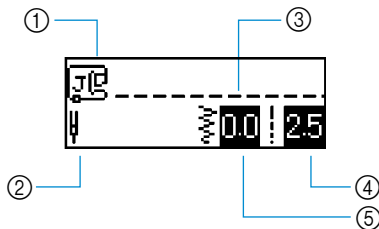

- ① Presser foot that should be used
- ② Single or twin needle
- ③ Selected stitch
- ④ Stitch length (mm)
- ⑤ Stitch width (mm)



### Memo

- For details on the error messages that appear when an operation is performed incorrectly, refer to “Error messages” (page 141).

## Checking machine operating procedures

Simple descriptions on replacing the presser foot, threading the upper thread, winding the bobbin and installing the bobbin can be displayed in the LCD.

### 1 Turn on the sewing machine.

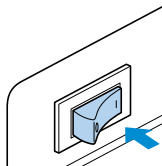

▶ The LCD comes on.

### 2 Press (sewing machine help key) in the operation panel.

▶ The sewing machine help screen appears.

### 3 Press , , and (arrow keys) until the image illustrating desired topic is selected.

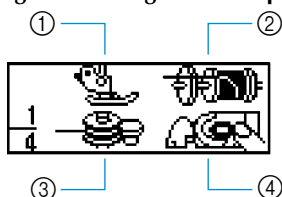

- ① Replacing the presser foot
- ② Threading the upper thread
- ③ Winding the bobbin
- ④ Installing the bobbin

### 4 Press (OK key).

▶ The first screen describing the procedure for the selected topic appears.

### 5 To display the next screen, press . To return to the previous screen, press .

□ Example: Upper threading

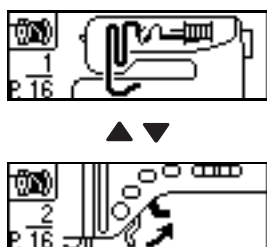

### 6 When you are finished with the help screen, press (OK key).

▶ The initial stitch screen appears again.



#### Note

- For details on each topic, refer to the corresponding page in this Operation Manual.

## Changing the Machine Settings

Various sewing machine operations and sewing settings can be changed.

### Changing the settings

The general procedure for changing machine settings is described below.



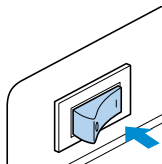

- 1 Turn on the sewing machine.



▶ The LCD comes on.

- 2 Press  (settings key) in the operation panel.

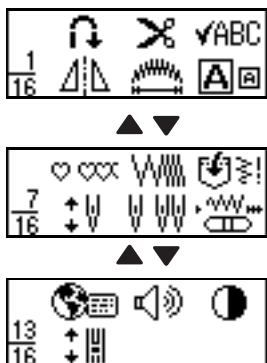

▶ The settings screen appears.

- 3 Press , ,  and  (arrow keys) until the stitch or machine attribute that you wish to set is selected.



- 4 Press  (OK key).

▶ A screen containing settings for the selected attribute appears.

- 5 Press , ,  and  (arrow keys) until the desired setting is selected.

▶ The setting is changed.

- 6 Press  (OK key).

▶ The initial stitch screen appears again.







## ■ List of stitch or machine attribute

The stitch or machine attribute that can be set are listed below. For details on each attribute, refer to the corresponding reference page.

Attribute	Icon	Details	Reference
Automatic reverse/reinforcement stitching		Specifies automatic reverse/reinforcement stitching.	page 57
Automatic thread-cutting		Specifies automatic thread-cutting.	page 58
Check pattern		Allows combined patterns to be checked.	page 116
Left/right mirror imaging		Mirror images patterns along a vertical axis.	page 119
Pattern length		Adjusts the length of satin stitches.	page 118
Pattern size		Sets the size of patterns to be large or small.	page 117
Repeated/single sewing		Specifies whether the pattern will be sewn once or repeatedly.	page 115
Stitching density		Specifies the sewing density of the stitching.	page 118
Save settings		Allows adjusted pattern widths and lengths to be saved.	page 60
Needle position		Specifies where the needle is positioned when the sewing machine is stopped.	page 16
Twin needle sewing		Specifies the twin needle.	page 28
Stitch width control		Allows the stitch width to be adjusted with the sewing speed controller.	page 99
Language		Allows the language used in the screens to be changed.	page 17
Buzzer		Specifies whether or not a beep is sounded with each operation.	page 143
LCD brightness		Adjusts the brightness of the LCD.	page 16
Vertical pattern adjustment		Adjusts the up and down position of the pattern.	page 121





## Changing the needle stop position

When the sewing machine is purchased, it is set to leave the needle lowered in the fabric when sewing is stopped. However, the machine can be set to instead leave the needle raised when sewing is stopped.

- 1 Press  (settings key) in the operation panel, and then press , ,  and  (arrow keys) until  is selected.



- 2 Press  (OK key).
  - ▶ The screen for changing the needle stop position appears.

- 3 Press  to select . To return to , press .

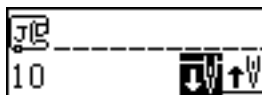







- ▶ The machine is now set to stop with the needle in the raised position.



- 4 Press  (OK key).
  - ▶ The initial stitch screen appears again.

## Adjusting the brightness of the LCD

The brightness of the LCD can be adjusted.

- 1 Press  (settings key) in the operation panel, and then press , ,  and  (arrow keys) until  is selected.



- 2 Press  (OK key).
  - ▶ The screen for changing the brightness of the LCD appears.
- 3 To make the LCD brighter, press  (-). To make the LCD darker, press  (+).

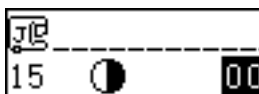







- ▶ The brightness of the LCD is changed.



- 4 Press  (OK key).
  - ▶ The initial stitch screen appears again.

## Changing the screen language

The language used in the screens that are displayed can be changed to one of the many available. When the sewing machine is purchased, the screens appear in English.

- 1 Press  (settings key) in the operation panel, and then press , ,  and  (arrow keys) until  is selected.



- 2 Press  (OK key).
  - ▶ The screen for changing the language of the screens appears.
- 3 Press  or  until the desired language is selected.

The language can be changed to one of the available: English, German, French, Italian, Dutch, Spanish, Danish, Norwegian, Swedish, Finnish, Portuguese, Russian, Korean, Japanese or others.

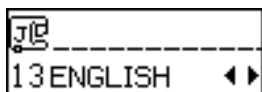

- ▶ The language of the screens is changed.
- 4 Press  (OK key).
    - ▶ The initial stitch screen appears again.

## Winding/Installing the Bobbin

This section describes how to wind the thread onto the bobbin, and then insert the bobbin thread.

### Bobbin precautions

Be sure to observe the following precautions concerning the bobbin.

#### ! CAUTION

- Only use the bobbin (part code: SA156, XA5539-151) designed specifically for this sewing machine. Use of any other bobbin may result in injuries or damage to the machine.
- The enclosed bobbin was designed specifically for this sewing machine. If bobbins from older models are used, the machine will not operate correctly. Use only the enclosed bobbin or bobbins of the same type (part code: SA156, XA5539-151).

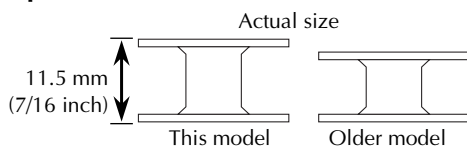

### Winding the bobbin

Wind the thread around the bobbin to prepare the bobbin thread.

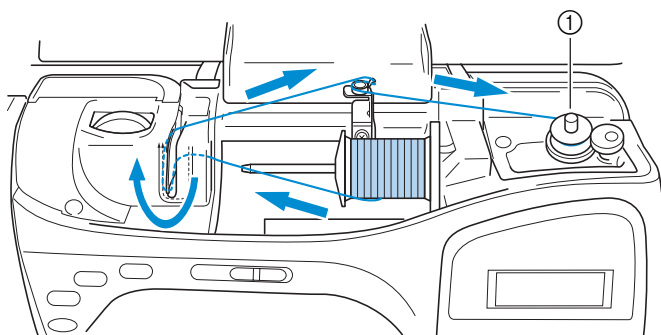

① Bobbin winder



#### Memo

- The order that the machine should be threaded for winding the bobbin is indicated by a broken line on the sewing machine. Be sure to thread the machine as indicated.



- 1** Turn on the sewing machine.

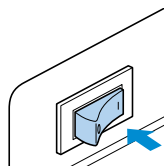

- 2** Lift open the upper cover.

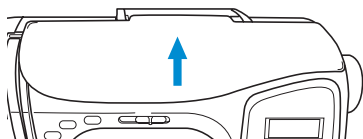

- 3** Place the bobbin on the bobbin winder shaft so that the spring on the shaft fits into the notch in the bobbin.

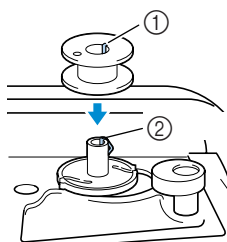

- ① Notch  
② Bobbin winder shaft spring

- 4** Slide the bobbin winder shaft to the right.

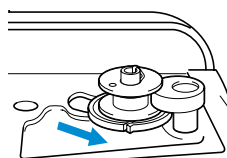

- 5** Remove the spool cap that is inserted onto the spool pin.

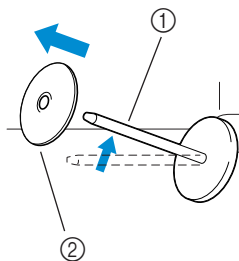

- ① Spool pin  
② Spool cap

- 6** Place the spool of thread for the bobbin onto the spool pin.

Slide the spool onto the pin so that the spool is horizontal and the thread unrolls from the bottom front of the spool.

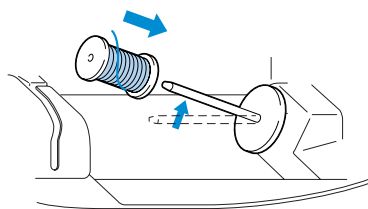

- If the spool is not positioned so that the thread unrolls correctly, the thread may become tangled around the spool pin.

- 7** Slide the spool cap onto the spool pin.

With the rounded side of the spool cap positioned toward the left, slide the spool cap onto the spool pin as far as possible until the right side of the spool touches the right end of the spool pin.

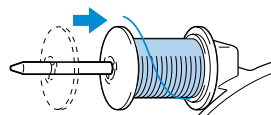

- Three spool cap sizes are available (large, medium and small). Use the spool cap with a diameter that is slightly larger than the diameter of the spool. The medium-sized spool cap is already on the spool pin when the sewing machine is purchased.

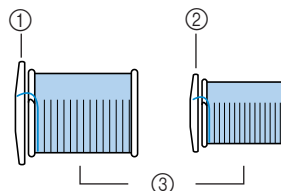

- ① Spool cap (large)  
② Spool cap (medium)  
③ Spool

- When using a spool of cross-wound thread, install the small spool cap with some space between the cap and the spool.

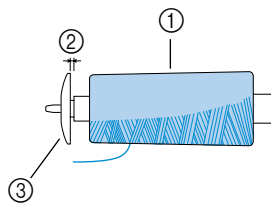

- ① Spool  
② Gap  
③ Spool cap (small)

**! CAUTION**

- If the spool or the spool cap is not positioned correctly, the thread may become tangled around the spool pin or the needle may break.
- Three spool cap sizes are available (large, medium and small), allowing you to choose a spool cap that best fits the size of spool being used. If the spool cap is too small for the spool being used, the thread may catch on the slit in the spool or the needle may break.

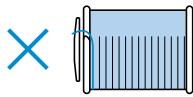

- 8** While holding the spool with your right hand, pull the thread with your left hand, and then pass the thread behind the thread guide cover to the front.

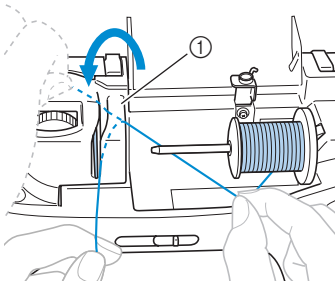

① Thread guide cover

- 9** Pass the thread under the thread guide plate from the right.

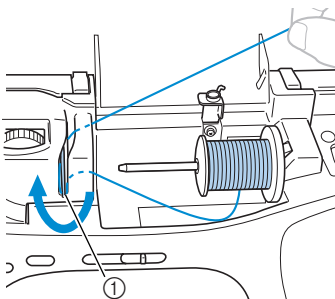

① Thread guide plate

- 10** Pull the thread to the right, pass it under the hook on the thread guide for bobbin winding, and then wind it counterclockwise between the discs.

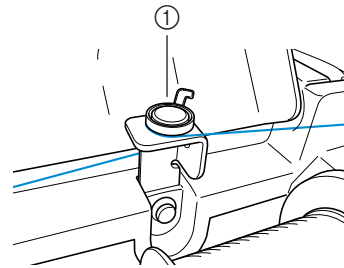
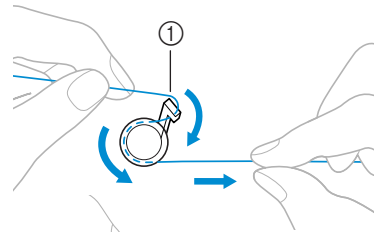

① Thread guide for bobbin winding

- 11** While using your left hand to hold the end of the thread that wraps around the thread guide for bobbin winding, use your right hand to wind the free end of the thread clockwise around the bobbin four or five times.

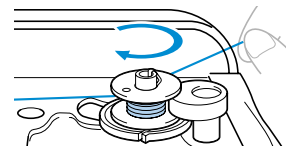

- 12** Pull the thread to the right and pass it through the slit in the bobbin winder seat.

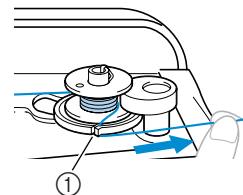

① Slit in bobbin winder seat (with built-in cutter)

- ▶ The thread is cut to a suitable length.

**! CAUTION**

- Be sure to cut the thread as described on the previous page. If the bobbin is wound without cutting the thread using the cutter built into the slit in the bobbin winder seat, the thread may become tangled in the bobbin or the needle may bend or break when the bobbin thread starts to run out.

- 13** Slide the sewing speed controller to the right (so that the speed will be fast).

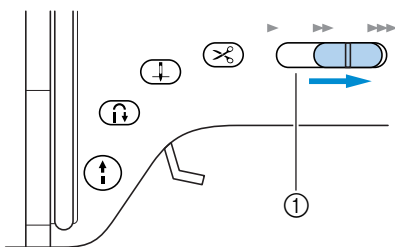

① Sewing speed controller

- 14** Press  (start/stop button) once.

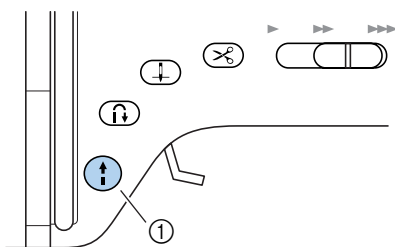

① Start/stop button

- ▶ The bobbin starts spinning and the thread is wound around the bobbin.
- ▶ The bobbin stops spinning when it is full.

- 15** Press  (start/stop button) once.

- ▶ The sewing machine stops.

- 16** Use scissors to cut the end of the thread wound around the bobbin.

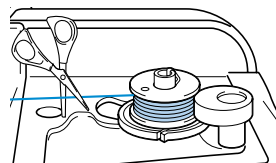

- 17** Slide the bobbin winder shaft to the left.

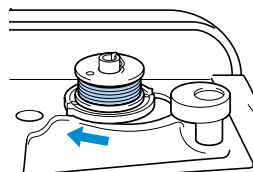

- 18** Remove the bobbin from the shaft.

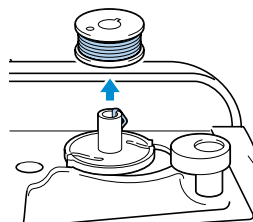

- 19** Slide the sewing speed controller back to its original position.

**! CAUTION**

- Use a bobbin thread that has been correctly wound, otherwise the needle may break or the thread tension will be incorrect.

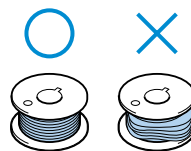
**Memo**

- When the sewing machine is started or the balance wheel is turned after winding the thread around the bobbin, the machine will make a clicking sound; this is not a malfunction.

## Installing the bobbin

Install the bobbin wound with thread.

### CAUTION

- Use a bobbin thread that has been correctly wound, otherwise the needle may break or the thread tension will be incorrect.

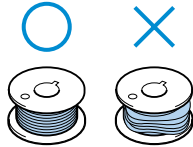

- The bobbin was designed specifically for this sewing machine. If bobbins from older models are used, the machine will not operate correctly. Use only the enclosed bobbin or bobbins of the same type (part code: SA156, XA5539-151).

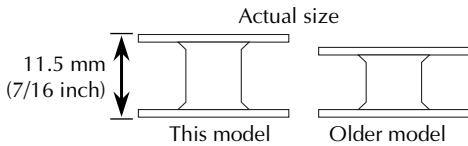

### Memo

- The order that the bobbin thread should be passed through the shuttle is indicated by marks around the shuttle. Be sure to thread the machine as indicated.

- 1 Slide the bobbin cover latch to the right.

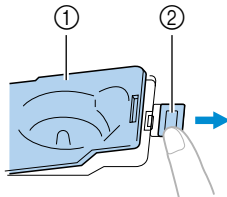

- ① Bobbin cover
- ② Latch

▶ The bobbin cover opens.

- 2 Remove the bobbin cover.

- 3 Hold the bobbin with your right hand and hold the end of the thread with your left.

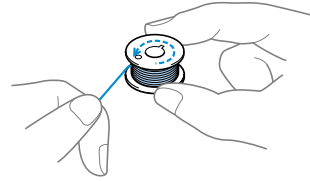

- Be careful not to drop the bobbin.

- 4 Insert the bobbin into the shuttle so that the thread unrolls to the left.

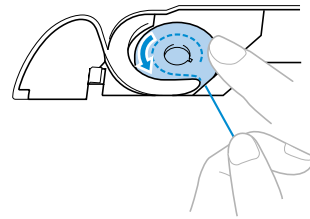

- Be sure to insert the bobbin correctly.

- 5 Lightly hold down the bobbin with your right hand, and then guide the thread as shown with your left hand.

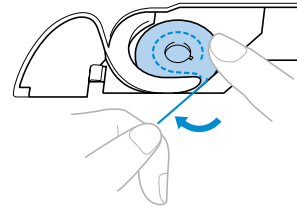

- 6 Pass the thread through the slot as shown, and then pull the thread out toward the front.

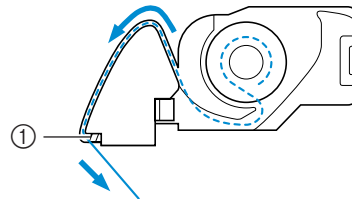

- ① Cutter

▶ The cutter cuts the thread.

**! CAUTION**

- Be sure to hold down the bobbin with your finger and unroll the bobbin thread correctly, otherwise the thread may break or the thread tension will be incorrect.

**7 Reattach the bobbin cover.**

Insert the tab in the lower-left corner of the bobbin cover, and then lightly press down on the right side.

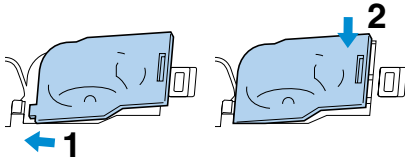

► The lower threading is finished.

Next, thread the upper thread. Continue with the procedure in “Upper Threading” (on the next page).

**Memo**

- You can begin sewing without pulling up the bobbin thread. If you wish to pull up the bobbin thread before starting to sew, pull up the thread according to the procedure in “Pulling up the bobbin thread” (page 31).

## Upper Threading

In this section, the procedures for positioning the spool for the upper thread and threading the needle are described.

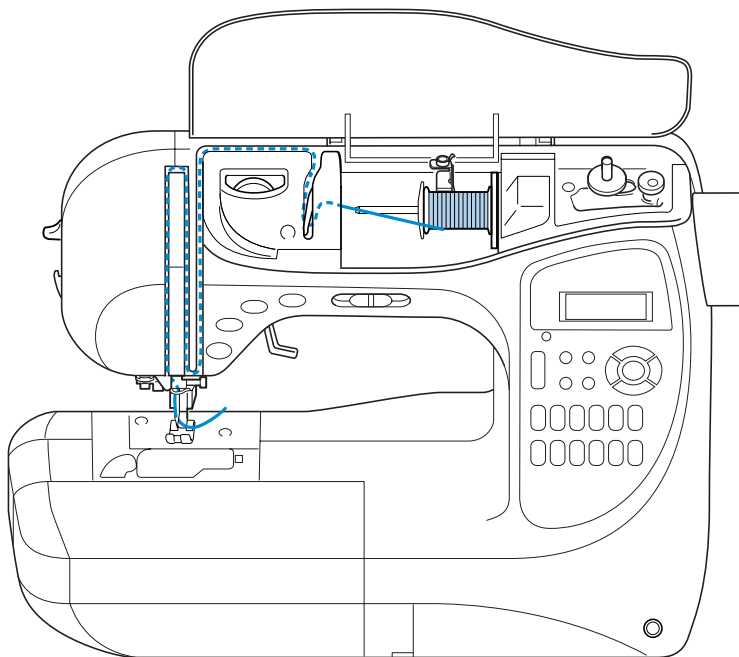

### CAUTION

- When threading the upper thread, carefully follow the instructions. If the upper threading is not correct, the thread may become tangled or the needle may bend or break.



### Memo

- The order that the machine should be threaded is indicated by a solid line on the sewing machine. Be sure to thread the machine as indicated.

### Threading the upper thread

- 1 Turn on the sewing machine.

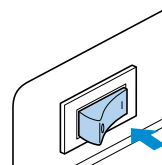

- 2 Raise the presser foot lever.

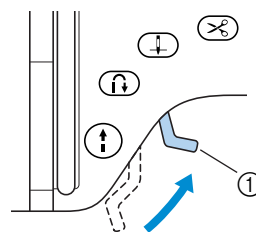

① Presser foot lever

▶ The presser foot is raised.

- If the presser foot is not raised, the sewing machine cannot be threaded correctly.

**3 Press**  **(needle position button) once or twice to raise the needle.**

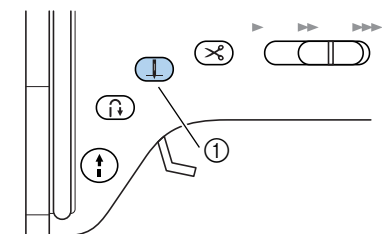

① Needle position button

- If the needle is not correctly raised, the sewing machine cannot be threaded. Check that the mark on the balance wheel is facing up as shown in the illustration below. If the balance wheel is not in this position, be sure to press the needle position button to raise the needle before using the needle threader.

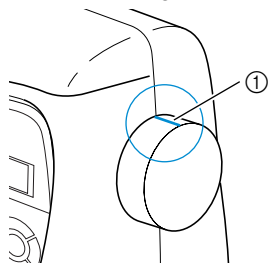

① Mark on balance wheel

**4 Lift open the upper cover.**

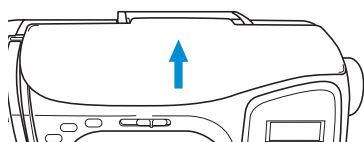

**5 Remove the spool cap that is inserted onto the spool pin.**

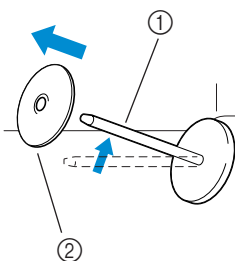

① Spool pin  
② Spool cap

**6 Place the spool for the upper thread onto the spool pin.**

Slide the spool onto the pin so that the spool is horizontal and the thread unrolls from the bottom front of the spool.

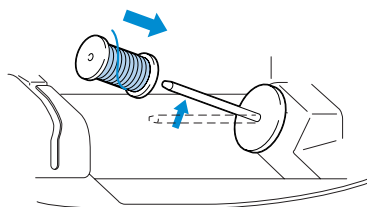

- If the spool is not positioned so that the thread unrolls correctly, the thread may become tangled around the spool pin.

**7 Slide the spool cap onto the spool pin.**

With the rounded side of the spool cap positioned toward the left, slide the spool cap onto the spool pin as far as possible until the right side of the spool touches the right end of the spool pin.

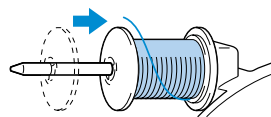

- Three spool cap sizes are available (large, medium and small). Use the spool cap with a diameter that is slightly larger than the diameter of the spool. The medium-sized spool cap is already on the spool pin when the sewing machine is purchased.

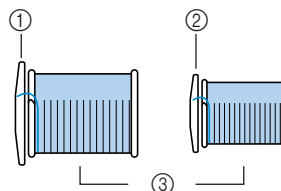

① Spool cap (large)  
② Spool cap (medium)  
③ Spool

- When using a spool of cross-wound thread, install the small spool cap with some space between the cap and the spool.

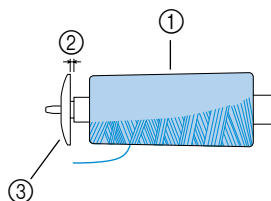

① Spool  
② Gap  
③ Spool cap (small)

**CAUTION**

- If the spool or the spool cap is not positioned correctly, the thread may become tangled around the spool pin or the needle may break.
- Three spool cap sizes are available (large, medium and small), allowing you to choose a spool cap that best fits the size of spool being used. If the spool cap is too small for the spool being used, the thread may catch on the slit in the spool or the needle may break.

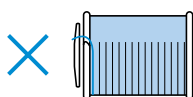

- 8** While holding the spool with your right hand, pull the thread with your left hand, and then pass the thread behind the thread guide cover to the front.

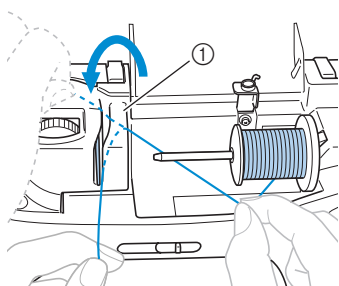

① Thread guide cover

- 9** Pass the thread under the thread guide plate from the right.

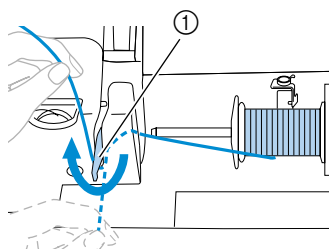

① Thread guide plate

- 10** While using your right hand to hold the thread passed under the thread guide plate taut, pass the thread through the guides in the order (up → left → down → up → down) shown.

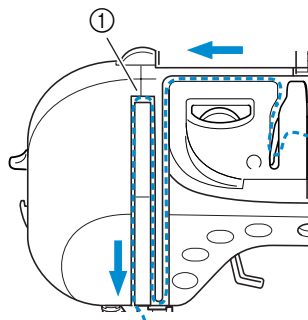

① Shutter

The following diagram shows the shutter position when the presser foot is lowered. Since the shutter is closed when the presser foot is lowered, the machine cannot be threaded. Be sure to raise the presser foot so that the shutter is open in order to thread the machine.

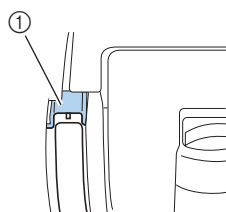

① Shutter

- 11** Pass the thread through the thread hook at the base of the needle bar.

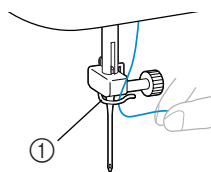

① Thread hook

Next, use the needle threader to thread the needle. Continue with the procedure in "Threading the needle" (on the next page).



## Threading the needle

The needle threader can be used with needle size 75/11 through 100/16. For more details on the needle, refer to “Needle types and their uses” (page 33).

- 1 With your left hand, hold the end of the thread passed through the needle bar thread hook, and then pass the thread through the thread guide discs from the front.

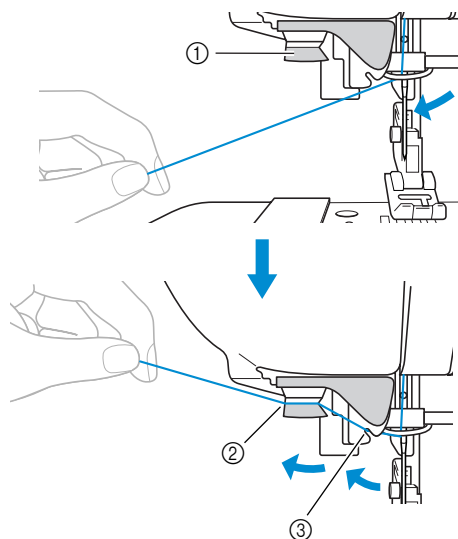

- 1 Thread guide discs
- 2 Pass to the back.
- 3 Pass through the slit.

- 2 Cut the thread with the cutter on the left side of the machine.

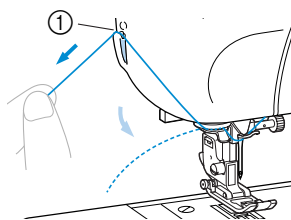

- 1 Thread cutter

- 3 Lower the presser foot lever.

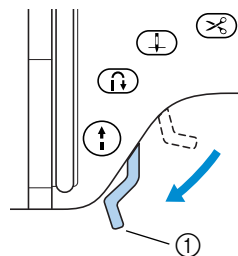

- 1 Presser foot lever
- The presser foot is lowered.

- 4 Lower the needle threader lever until it clicks.

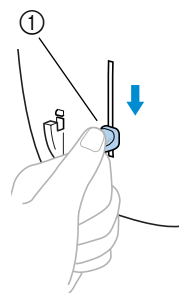

- 1 Needle threader lever
- The thread is passed through the eye of the needle.

- 5 Release the needle threader lever.

- 6 Carefully pull on the loop of thread passed through the eye of the needle to pull out the end of the thread.

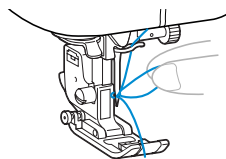

- 7** Raise the presser foot lever, pass the thread through the presser foot, and then pull out about 5 cm (2 inch) of thread toward the rear of the machine.

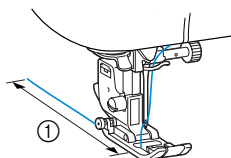

① 5 cm (2 inch)

- The lower threading is finished.

Now that the upper threading and the lower threading are finished, you are ready to begin sewing.



### Note

- If the needle is not raised, the needle threader cannot thread the needle. Be sure to press the needle position button to raise the needle before using the needle threader.
- If the twin needle is installed, the needle threader cannot be used. For details, refer to "Using the twin needle" (at the right).

## Using the twin needle

With the twin needle, you can sew two parallel lines of the same stitch with two different threads. Both upper threads should have the same thickness and quality. Be sure to use the twin needle, the extra spool pin and the spool cap. For details on the stitches that can be sewn with the twin needle, refer to "Stitch Settings" (page 128).

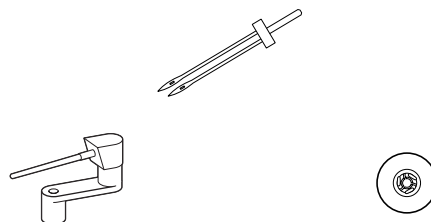

### ! CAUTION

- **Only use the twin needle (part code: X59296-051). Use of any other needle may bend the needle or damage the machine.**
- **Never use bent needles. Bent needles can easily break, possibly resulting in injuries.**

- 1 Install the twin needle.**
  - For details on installing a needle, refer to "Replacing the needle" (page 35).
- 2 Thread the upper thread for the left needle eye.**
  - For details, refer to steps ① through ⑪ of "Threading the upper thread" (page 24).

- 3** **Manually thread the left needle with the upper thread.**  
Pass the thread through the eye of the needle from the front.

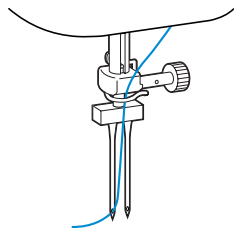

- The needle threader cannot be used with the twin needle. If the needle threader is used with the twin needle, the sewing machine may be damaged.

- 4** **Insert the extra spool pin onto the bobbin winder shaft.**  
Insert the extra spool pin so that it is perpendicular to the bobbin winder shaft.

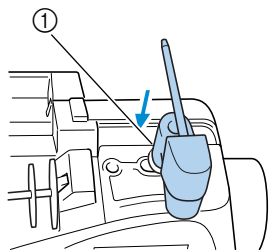

① Bobbin winder shaft

- 5** **Swing down the spool pin so that it is horizontal.**

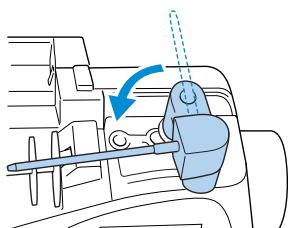

- 6** **Place the upper thread spool for the needle on the right side onto the extra spool pin, and then secure it with the spool cap.**  
The thread should unroll from the top front of the spool.

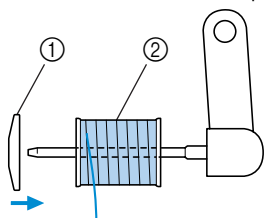

① Spool cap  
② Spool

- 7** **Thread the upper thread in the same way that the upper thread for the left side was threaded.**

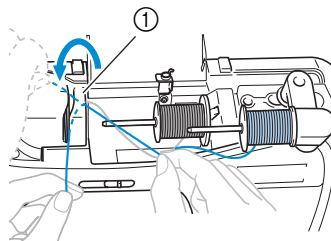

① Thread guide cover

- For details, refer to step **8** through **10** of “Threading the upper thread” (page 26).

- 8** **Without passing the thread through the needle bar thread hook, manually thread the right needle.**  
Pass the thread through the eye of the needle from the front.

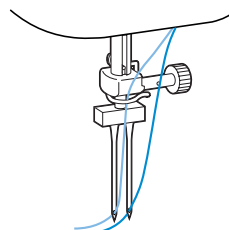

- The needle threader cannot be used with the twin needle. If the needle threader is used with the twin needle, the sewing machine may be damaged.

- 9** **Attach zigzag foot “J”.**  
• For details on changing the presser foot, refer to “Replacing the presser foot” (page 37).

**! CAUTION**



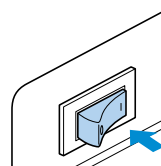

- When using the twin needle, be sure to attach zigzag foot “J”, otherwise the needle may break or the machine may be damaged.

- 10** **Turn on the sewing machine.**







- ▶ The LCD comes on.

- 11** Press  (settings key) in the operation panel.  
▶ The settings screen appears.

- 12** Press , ,  and  (arrow keys) until  is selected.



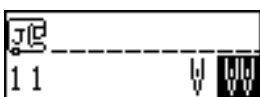

- 13** Press  (OK key).  
▶ The screen for selecting the twin needle appears.

- 14** Press  to select .  
To return to , press .



- ▶ The twin needle can now be used.

- 15** Press  (OK key).  
▶ The initial stitch screen appears again, and  appears in the lower-left corner of the screen.

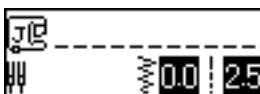

- Even after the sewing machine is turned off, the twin needle setting is not cancelled.

### CAUTION

- When using the twin needle, be sure to select the twin needle setting, otherwise the needle may break or the machine may be damaged.

- 16** Select a stitch.
- For details on selecting a stitch, refer to “Selecting stitching” (page 68).
  - For details on the stitches that can be sewn with the twin needle, refer to “Stitch Settings” (page 128).

### CAUTION

- When using the twin needle, be sure to select an appropriate stitch, otherwise the needle may break or the machine may be damaged.

- 17** Start sewing.
- For details on starting to sew, refer to “Starting to sew” (page 49).
  - ▶ Two lines of stitching are sewn parallel to each other.

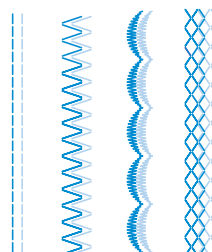

### CAUTION

- When changing the sewing direction, press  (needle position button) to raise the needle from the fabric, and then raise the presser foot lever and turn the fabric.

## Using thread that winds off quickly

When using thread that winds off quickly, such as transparent nylon thread or metallic thread, place the enclosed spool net over the spool before placing the spool of thread onto the spool pin. If the spool net is too long, fold it to fit the size of the spool.

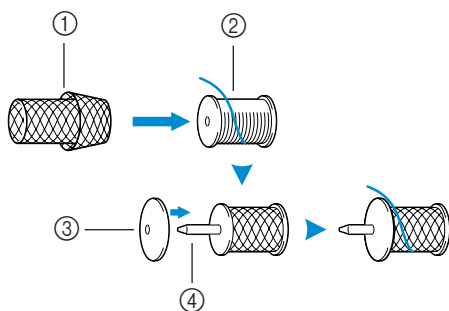

- ① Spool net
- ② Spool
- ③ Spool cap
- ④ Spool pin

## Pulling up the bobbin thread

When making gathers or before free-motion quilting, first pull up the bobbin thread as described below.

- ① **Insert the bobbin into the shuttle.**
  - Refer to steps ① through ⑤ of "Installing the bobbin" (page 22).

- ② **Pass the bobbin thread through the slot.**  
Do not cut the thread with the cutter.

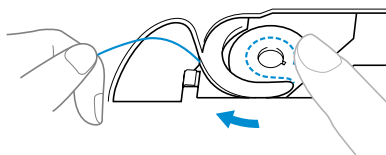

- ③ **While lightly holding the upper thread with your left hand, press**  **(needle position button) twice to raise the needle.**

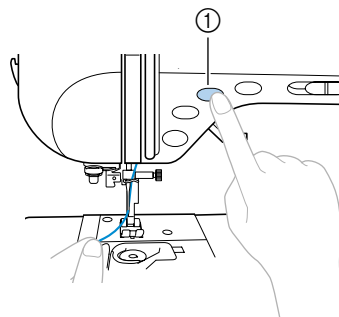

- ① Needle position button
- ▶ The bobbin thread is looped around the upper thread and can be pulled up.

- ④ **Carefully pull the upper thread upward to pull out the end of the bobbin thread.**

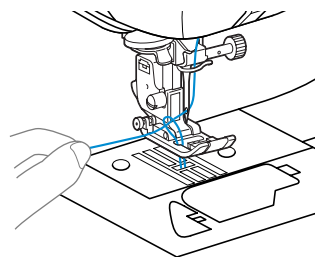

- 5 Pull out about 5 cm (2 inch) of the bobbin thread under the presser foot toward the rear of the machine.

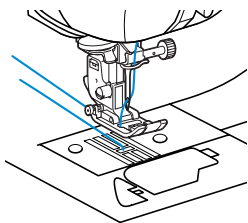

- 6 Reattach the bobbin cover. Insert the tab in the lower-left corner of the bobbin cover, and then lightly press down on the right side.

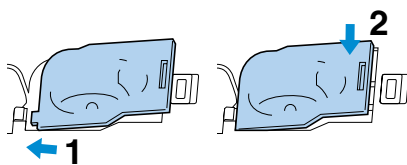

## Replacing the Needle

This section provides information on sewing machine needles.

### Needle precautions

Be sure to observe the following precautions concerning the handling of the needle. Failure to observe these precautions is extremely dangerous, for example, if the needle breaks and fragments are dispersed. Be sure to read and carefully follow the instructions below.

#### CAUTION

- Only use home sewing machine needles. Use of any other needle may bend the needle or damage the machine.
- Never use bent needles. Bent needles can easily break, possibly resulting in injuries.

### Needle types and their uses

The sewing machine needle that should be used depends on the fabric and thread thickness. Refer to the following table when choosing the thread and needle appropriate for the fabric that you wish to sew.

Fabric Type/Application		Thread		Size of Needle
		Type	Size	
Medium weight fabrics	Broadcloth	Cotton thread	60–80	75/11–90/14
	Taffeta	Synthetic thread		
	Flannel, Gabardine	Silk thread	50–80	
Thin fabrics	Lawn	Cotton thread	60–80	65/9–75/11
	Georgette	Synthetic thread		
	Poral	Silk thread	50–80	
Thick fabrics	Denim	Cotton thread	30–50	90/14–100/16
	Corduroy	Synthetic thread	50	
	Tweed	Silk thread		
Stretch fabrics	Jersey	Thread for knits	50–60	Ball point needle (golden colored) 75/11–90/14
	Tricot			
Easily frayed fabrics		Cotton thread	50–80	65/9–90/14
		Synthetic thread		
		Silk thread		
For top-stitching		Synthetic thread	30	90/14–100/16
		Silk thread		

**Memo**

- The smaller the thread number, the thicker the thread, and the larger the needle number, the thicker the needle.
- Use the ball point needle when sewing on stretch fabrics or fabrics where skipped stitches easily occur.
- Use a 90/14 to 100/16 needle with transparent nylon threads, regardless of the fabric being sewn.
- A 75/11 needle is already installed when the sewing machine is purchased.

**CAUTION**

- The appropriate fabric, thread and needle combinations are shown in the table on the previous page. If the combination of the fabric, thread and needle is not correct, particularly when sewing thick fabrics (such as denim) with thin needles (such as 65/9 to 75/11), the needle may bend or break. In addition, the stitching may be uneven or puckered or there may be skipped stitches.

**Checking the needle**

Sewing with a bent needle is extremely dangerous since the needle may break while the machine is being operated.

Before using the needle, place the flat side of the needle on a flat surface and check that the distance between the needle and the flat surface is even.

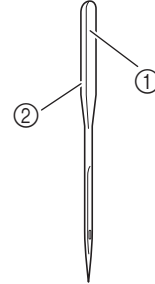

- ① Flat side
- ② Needle type marking

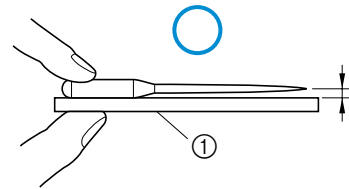
**Correct needle**

- ① Flat surface

**Incorrect needle**

If the distance between the needle and the flat surface is not even, the needle is bent. Do not use a bent needle.

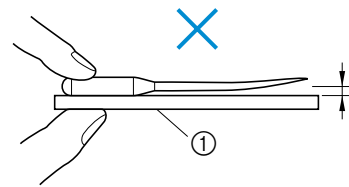

- ① Flat surface



## Replacing the needle

Replace the needle as described below. Use the screwdriver and a needle that has been determined to be straight according to the instructions in "Checking the needle".

- 1 Press  (needle position button) once or twice to raise the needle.

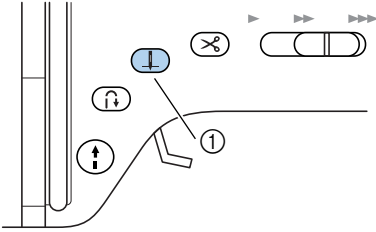

① Needle position button

- 2 Turn off the sewing machine.

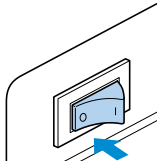

### CAUTION

- Before replacing the needle, be sure to turn off the sewing machine, otherwise injuries may occur if the start/stop button is accidentally pressed and the machine starts sewing.

- 3 Lower the presser foot lever.

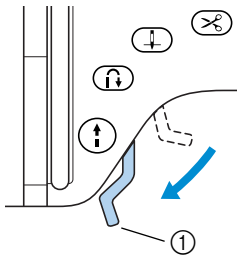

① Presser foot lever

- 4 Hold the needle with your left hand, and then use a screwdriver to turn the needle clamp screw counterclockwise to remove the needle.

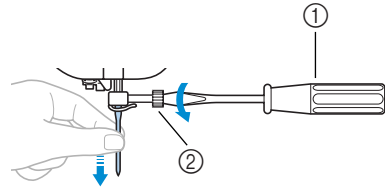

- ① Screwdriver
  - ② Needle clamp screw
- Do not apply a strong force when loosening or tightening the needle clamp screw, otherwise certain parts of the sewing machine may be damaged.

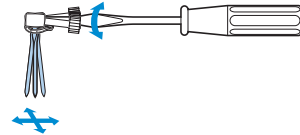

- 5 With the flat side of the needle toward the rear of the machine, insert the needle until it touches the needle stopper.

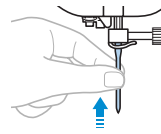

- 6 While holding the needle with your left hand, use the screwdriver to tighten the needle clamp screw.

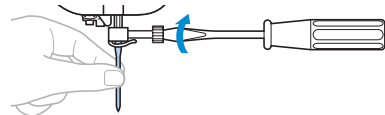

Install the twin needle in the same way.

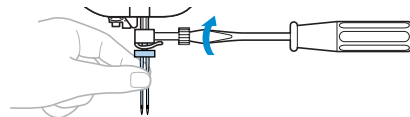

 **CAUTION**

- **Be sure to insert the needle until it touches the needle stopper and securely tighten the needle clamp screw with the screwdriver, otherwise the needle may break or damage may result.**

CONTENTS

GETTING READY

SEWING BASICS

UTILITY STITCHES

APPENDIX

INDEX

## Replacing the Presser Foot

The presser foot presses down on the fabric.

### Presser foot precautions

Be sure to observe the following precautions concerning the needles.

#### ! CAUTION

- Use the presser foot appropriate for the type of stitch that you wish to sew, otherwise the needle may hit the presser foot, causing the needle to bend or break.
- Only use presser feet designed specifically for this sewing machine. Use of any other presser foot may result in injuries or damage to the machine.

### Replacing the presser foot

Replace the presser foot as described below. For details on using the side cutter "S", refer to "Sewing overcasting stitches using the optional side cutter" (page 72).

- 1 Press  (needle position button) once or twice to raise the needle.

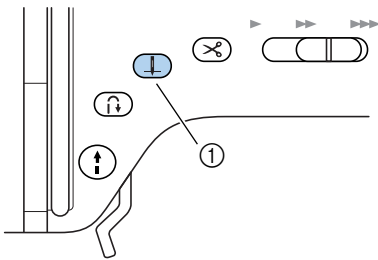

- ① Needle position button
- ▶ The needle is raised.

- 2 Turn off the sewing machine.

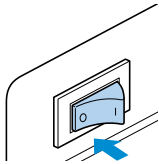

#### ! CAUTION

- Before replacing the presser foot, be sure to turn off the sewing machine, otherwise injuries may occur if the start/stop button is accidentally pressed and the machine starts sewing.

- 3 Raise the presser foot lever.

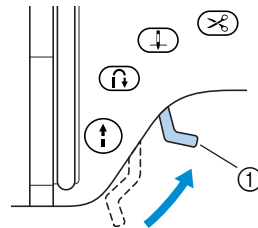

- ① Presser foot lever
- ▶ The presser foot is raised.

- 4** Press the black button at the back of the presser foot holder.

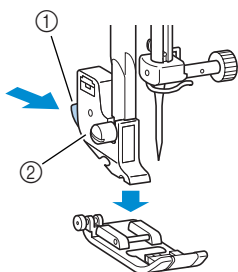

- ① Black button  
② Presser foot holder

► The presser foot holder releases the presser foot.

- 5** Place a different presser foot below the holder so that the presser foot pin is aligned with the notch in the holder.

Position the presser foot so the letter indicating the presser foot type (A, G, I, J, M, N or R) is positioned to be read.

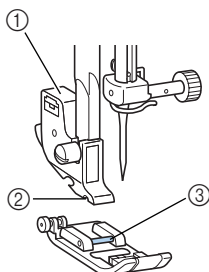

- ① Presser foot holder  
② Notch  
③ Pin

- 6** Slowly lower the presser foot lever so that the presser foot pin snaps into the notch in the presser foot holder.

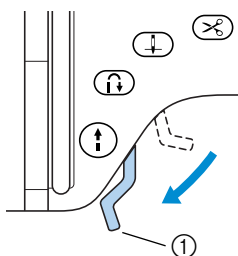

- ① Presser foot lever

► The presser foot is attached.

- 7** Raise the presser foot lever to check that the presser foot is securely attached.

## Note

- When a stitch is selected, the icon for the presser foot that should be used appears in the screen. Check that the correct presser foot is attached before starting to sew. If the wrong presser foot is installed, turn off the sewing machine, attach the correct presser foot, and then select the desired stitch again.



**Buttonhole foot "A"**



**Overcasting foot "G"**



**Zigzag foot "J"**



**Button fitting foot "M"**



**Monogramming foot "N"**



**Blind stitch foot "R"**



**Side cutter "S"**

- For details on the presser foot that should be used with the selected stitch, refer to "Stitch Settings" (page 128).

## Adjusting the pressure of the presser foot

The amount of pressure that the presser foot applies to the fabric can be adjusted.

### 1 Lower the presser foot lever.

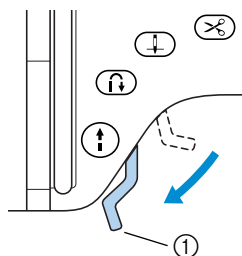

① Presser foot lever

### 2 Turn the presser foot dial at the back of the sewing machine.

The scale on the dial indicates the range from 1 (weak) to 4 (strong). Turn the dial to the right (smaller number) to decrease the pressure. Turn the dial to the left (larger number) to increase the pressure.

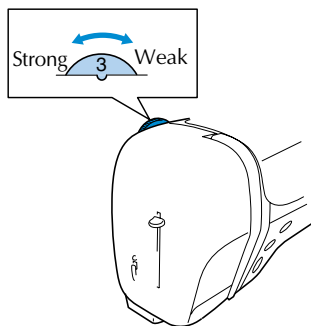

### 3 When you are finished sewing, reset the dial to 3 (standard).

## Removing the presser foot holder

Remove the presser foot holder when cleaning the sewing machine or when installing a presser foot that does not use the presser foot holder, such as the quilting foot. Use the screwdriver to remove the presser foot holder.

### ■ Removing the presser foot holder

#### 1 Remove the presser foot.

- For details, refer to “Replacing the presser foot” (page 37).

#### 2 Use the screwdriver to loosen the presser foot holder screw.

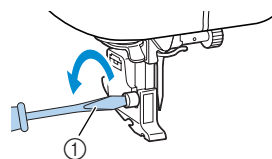

① Screwdriver

### ■ Attaching the presser foot holder

#### 1 Align the presser foot holder with the lower-left side of the presser bar.

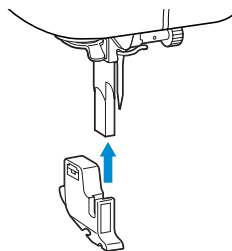

#### 2 Hold the presser foot holder in place with your right hand, and then tighten the screw using the screwdriver in your left hand.

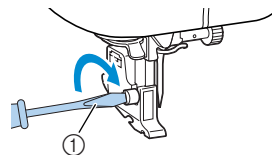

① Screwdriver

**Note**

- If the presser foot holder is not correctly installed, the thread tension will be incorrect.

## Using the walking foot

With the walking foot, both pieces of fabric are fed evenly by the feed dogs and the teeth on the presser foot. This is useful when sewing fabrics that are hard to feed such as vinyl and leather and when sewing fabrics that easily slip such as velvets or when quilting.

Use the screwdriver to attach the walking foot.

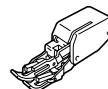

### ■ Attaching the walking foot

- ① **Remove the presser foot holder.**
  - For details, refer to “Removing the presser foot holder” (on the previous page).
- ② **Hook the connecting fork of the walking foot onto the needle clamp screw.**

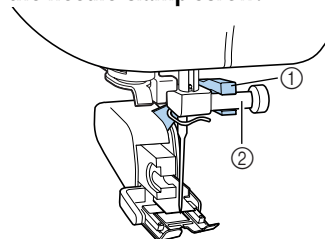

- ① Connecting fork
- ② Needle clamp screw

- ③ **Lower the presser foot lever, insert the presser foot holder screw, and then tighten the screw with the screwdriver.**

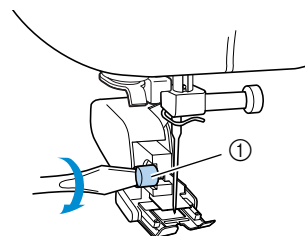

- ① Presser foot holder screw

**! CAUTION**

- Be sure to securely tighten the screw with the screwdriver, otherwise the needle may touch the presser foot, causing it to bend or break.
- Before starting to sew, slowly turn the balance wheel toward you and check that the needle does not touch the presser foot. If the needle hits the presser foot, the needle may bend or break.

**Note**

- When sewing with the walking foot, sew at a speed between slow and medium.

**■ Removing the walking foot**

- ① Press  (needle position button) once or twice to raise the needle.

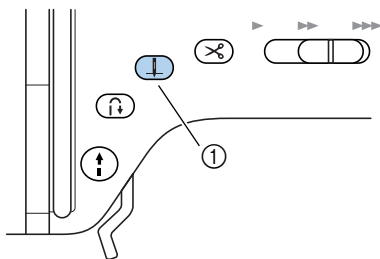

- ① Needle position button  
▶ The needle is raised.

- ② Turn off the sewing machine.

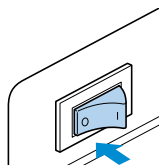

- ③ Raise the presser foot lever.

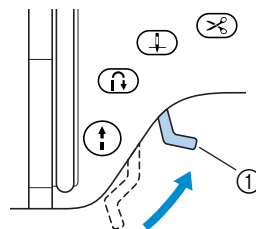

- ① Presser foot lever  
▶ The presser foot is raised.

- ④ With a screwdriver, loosen the presser foot holder screw, and then remove the walking foot.

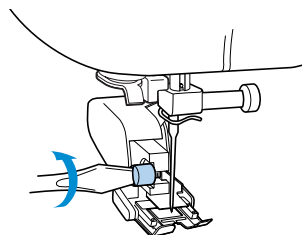

- ⑤ Attach the presser foot holder.
- For details, refer to "Removing the presser foot holder" (page 39).

**Memo**

- Only the straight stitch (with reinforcement stitching) and the zigzag stitch can be used with the walking foot. For details on the stitches, refer to "Stitch Settings" (page 128).

## Sewing Cylindrical or Large Pieces

When sewing cylindrical or large pieces of fabric, remove the flat bed attachment.

### Stitching cylindrical pieces

Removing the flat bed attachment makes it easier to sew cylindrical pieces such as cuffs and pant legs.

- 1 Pull the flat bed attachment off to the left.

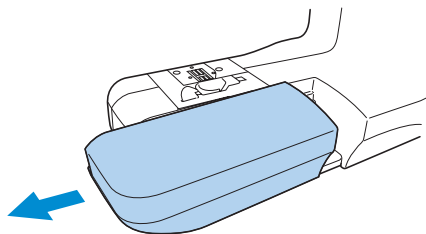

- ▶ With the flat bed attachment removed, free-arm sewing is possible.

- 2 Slide the part that you wish to sew onto the arm, and then sew from the top.

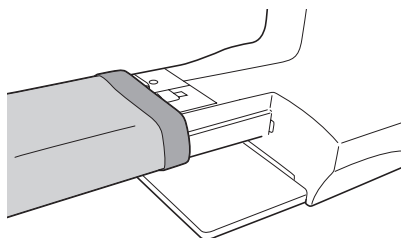

- 3 When you are finished with free-arm sewing, install the flat bed attachment back in its original position.

### Sewing large pieces of fabric

The optional wide table makes sewing large pieces of fabric easier.

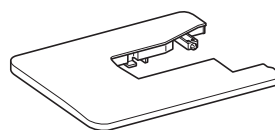

- 1 Open up the legs at the bottom of the wide table.

Pull out the four legs until they snap into place.

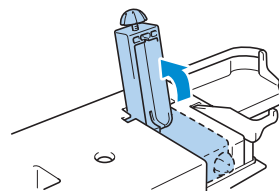

- 2 Pull the flat bed attachment off to the left.

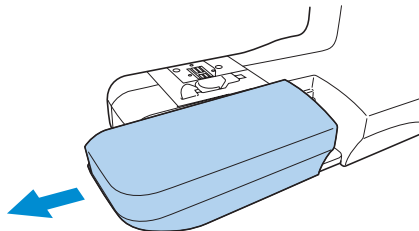

- ▶ With the flat bed attachment removed, free-arm sewing is possible.

- 3 Install the wide table. Keeping the wide table level, fully slide it into place.

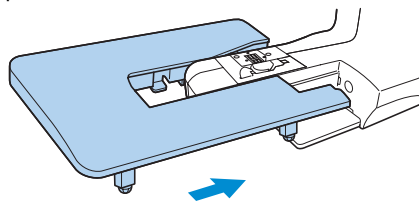

#### Note

- The optional wide table is available through your brother retailer.



- 4** Turn the screw at the bottom of the legs to adjust their height.

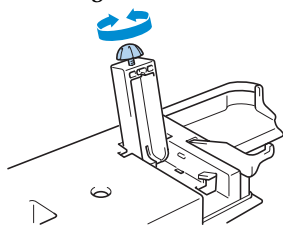

**! CAUTION**

- Do not move the sewing machine while the wide table is attached, otherwise damage or injuries may occur.

- 5** When you are finished using the wide table, remove it.  
While slightly lifting up the wide table, pull it off to the left.

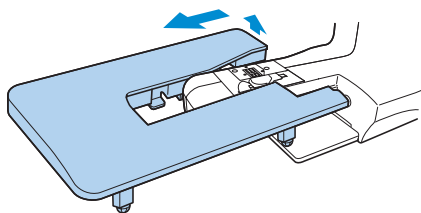

- 6** Install the flat bed attachment back in its original position.

**🔔 Memo**

- With the legs folded up, the wide table can be stored attached to the hard case.

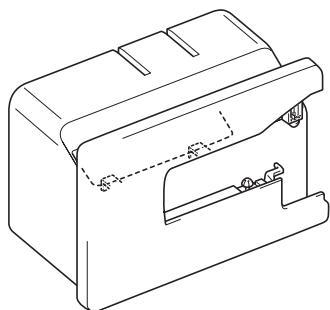

- The knee lifter can be stored attached to the bottom of the wide table.

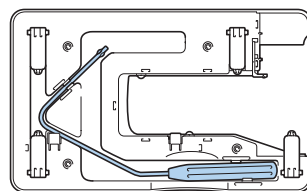

CONTENTS

GETTING READY

SEWING BASICS

UTILITY STITCHES

APPENDIX

INDEX

## 2

# SEWING BASICS

The necessary preparations for sewing are described in this chapter.

<b>Sewing</b> .....	<b>46</b>
<b>Adjusting the Thread Tension</b> .....	<b>54</b>
<b>Adjusting the Stitch Width and Length</b> .....	<b>55</b>
<b>Useful Functions</b> .....	<b>57</b>
<b>Useful Sewing Tips</b> .....	<b>62</b>

## Sewing

Basic sewing operations are described below.  
Before operating the sewing machine, read the following precautions.

### CAUTION

- While the machine is in operation, pay special attention to the needle location. In addition, keep your hands away from all moving parts such as the needle and balance wheel, otherwise injuries may occur.
- Do not pull or push the fabric too hard while sewing, otherwise injuries may occur or the needle may break.
- Never use bent needles. Bent needles can easily break, possibly resulting in injuries.
- Make sure that the needle does not strike basting pins, otherwise the needle may break or bend.

## General sewing procedure

Follow the basic procedures below to sew.

<b>1</b>	<b>Turn on the machine.</b>	Turn on the sewing machine. For details on turning on the machine, refer to “Turning on the machine” (page 11).
		↓
<b>2</b>	<b>Select the stitch.</b>	Select the stitch appropriate for the area to be sewn. For details on selecting a stitch, refer to “Selecting stitching” (page 68).
		↓
<b>3</b>	<b>Attach the presser foot.</b>	Attach the presser foot appropriate for the stitch. For details on replacing the presser foot, refer to “Replacing the presser foot” (page 37).
		↓
<b>4</b>	<b>Position the fabric.</b>	Place the area to be sewn under the presser foot. Be sure that the fabric pieces are sewn in the correct order and that the right and wrong sides of the fabric are aligned correctly. For details on positioning the fabric, refer to “Positioning the fabric” (page 48).
		↓
<b>5</b>	<b>Start sewing.</b>	Start sewing. For details on starting to sew, refer to “Starting to sew” (page 49).
		↓
<b>6</b>	<b>Cut the thread.</b>	Cut the thread at the end of sewing. The thread may also be cut automatically. For details on cutting the thread, refer to “Cutting the thread” (page 53).

## Positioning the fabric

Be sure that the fabric pieces are sewn in the correct order and that the right and wrong sides of the fabric are aligned correctly.

### 1 Turn on the sewing machine.

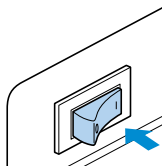

The straight stitch (left needle position) is automatically selected.

### 2 Press (needle position button) once or twice to raise the needle.

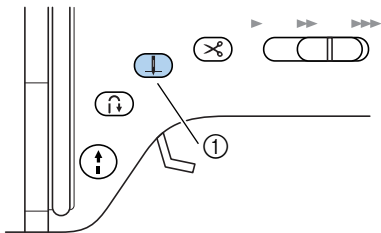

① Needle position button

### 3 Place the fabric under the presser foot.

- If the seam allowance is positioned on the right side, sewing in a straight line is easier and the extra fabric does not get in the way.

### 4 While holding the end of the thread and the fabric with your left hand, turn the balance wheel toward you with your right hand to lower the needle to the starting point of the stitching.

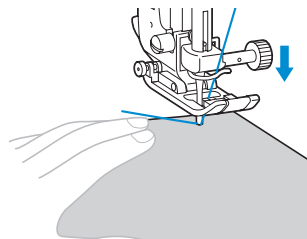
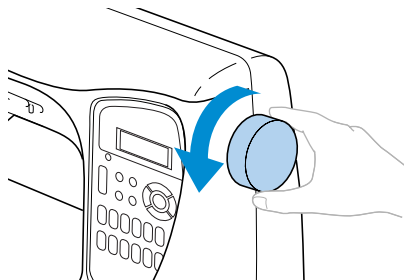

### 5 Lower the presser foot lever.

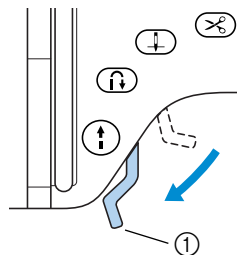

① Presser foot lever

- ▶ The fabric is now positioned to be sewn.

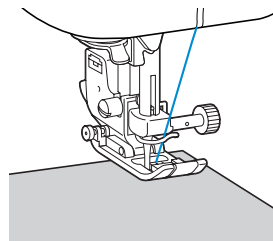

### Memo

- To adjust the pressure that the presser foot applies to the fabric, refer to “Adjusting the pressure of the presser foot” (page 39).

## Starting to sew

Once you are ready to start sewing, you can start the sewing machine. The sewing speed can be adjusted using either the operation buttons or the foot controller.

### ■ Using the operation buttons

Sewing can be started and stopped using the operation button  (start/stop button).

### ① Slide the sewing speed controller to the left or right to select the desired sewing speed.

Slide the sewing speed controller to the left to sew at a slower speed, or slide the speed controller to the right to sew at a faster speed.

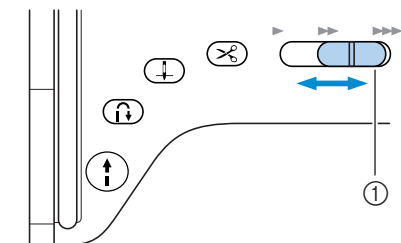

① Sewing speed controller

### ② Press (start/stop button) once.

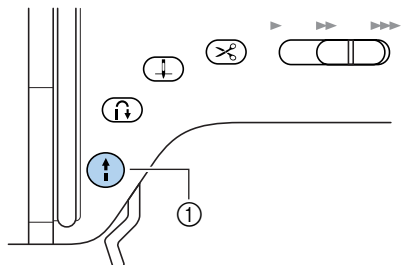

① Start/stop button

▶ The machine starts sewing.

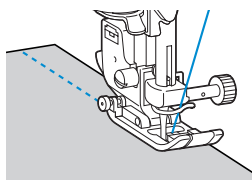

- If you continue to hold the start/stop button pressed immediately after the sewing starts, the machine will sew at a slow speed.

### ③ When the end of the stitching is reached, press (start/stop button) once.

▶ The machine stops sewing with the needle down (in the fabric).

### ④ When you are finished sewing, raise the needle, and then cut the threads.

- For details, refer to “Cutting the thread” (page 53).

### ■ Using the foot controller

Sewing can be started and stopped using the foot controller.

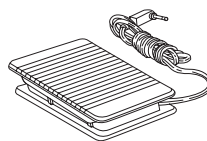

### ① Turn off the sewing machine.

When connecting the foot controller, be sure to turn off the sewing machine in order to prevent the machine from accidentally being started.

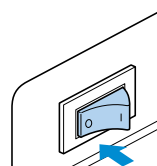

### ② Insert the foot controller plug into its jack on the side of the sewing machine.

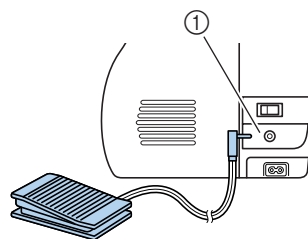

① Foot controller jack



### Note

(For U.S.A. only)

- Foot controller: Model N5V  
This foot controller can be used on this machine model NX-400/PC-420.

### 3 Turn on the sewing machine.

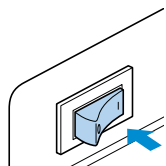

### 4 Slide the sewing speed controller to the left or right to select the desired sewing speed.

Slide the sewing speed controller to the left to sew at a slower speed, or slide the speed controller to the right to sew at a faster speed.

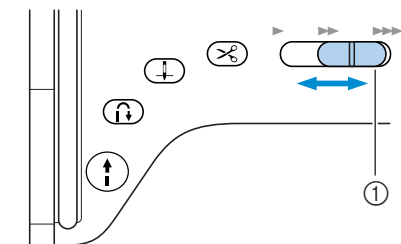

① Sewing speed controller

- The speed set using the sewing speed controller is the foot controller's maximum sewing speed.

### 5 Once you are ready to start sewing, slowly press down on the foot controller.

Pressing down on the foot controller increases the sewing speed; releasing the pressure on the foot controller decreases the sewing speed.

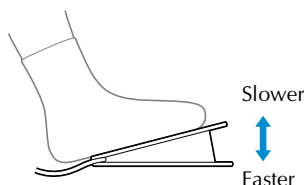

- Slowly press down on the foot controller. Pressing it down hard starts sewing too quickly.
- ▶ The machine starts sewing.

### 6 When the end of the stitching is reached, completely release the foot controller.

- ▶ The machine stops sewing with the needle lowered (in the fabric).

### 7 When you are finished sewing, raise the needle, and then cut the threads.

- For details, refer to "Cutting the thread" (page 53).



#### Memo

- When the foot controller is plugged in, the start/stop button cannot be used to start or stop sewing.
- When sewing is stopped, the needle remains lowered (in the fabric). The machine can be set so that the needle will stay up when sewing is stopped. For details on setting the machine so that the needle stays up when sewing is stopped, refer to "Changing the needle stop position" (page 16).



#### CAUTION

- Do not allow thread or dust to accumulate in the foot controller, otherwise a fire or an electric shock may occur.
- Do not place objects on the foot controller, otherwise damage to the machine or injuries may occur.
- If the machine is not to be used for a long period of time, unplug the foot controller, otherwise a fire or an electric shock may occur.



## Securing the stitching

When sewing with the straight stitch, for example, at the end of an opening or where seams do not overlap, use reverse stitching or reinforcement stitching to secure the end of the thread.

- 1 Lower the needle into the fabric at the beginning of the stitching, and then lower the presser foot lever.

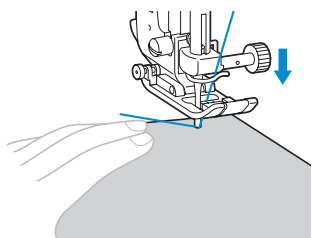

- 2 Press  (start/stop button) or press down on the foot controller.

At this time, if the start/stop button is held pressed, the machine sews at a low speed.

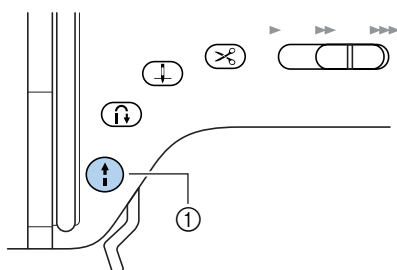

① Start/stop button

- For details, refer to “Starting to sew” (page 49).

► The machine starts sewing.

- 3 After sewing 3 to 5 stitches, press  (reverse/reinforcement stitch button). Keep the reverse/reinforcement stitch button held down until you reach the beginning of the stitching.

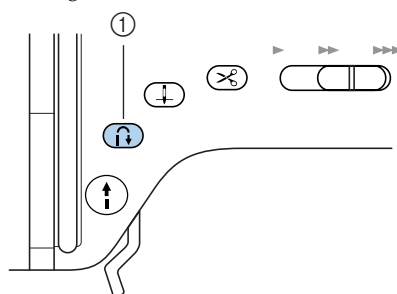

① Reverse/reinforcement stitch button

► While the reverse/reinforcement stitch button is held pressed, reverse stitches are sewn.

- 4 After sewing back to the beginning of the stitching, release the reverse/reinforcement stitch button.

► The machine stops sewing.

- 5 Press  (start/stop button), or press down on the foot controller.

► The machine starts sewing in the normal sewing direction.

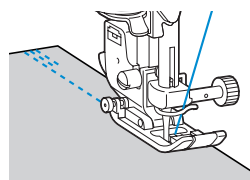

- 6 When the end of the stitching is reached, press  (reverse/reinforcement stitch button).

Keep the reverse/reinforcement stitch button held down until 3 to 5 reverse stitches are sewn.

► While the reverse/reinforcement stitch button is depressed, reverse stitches are sewn.

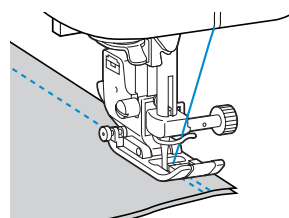

- 7** After 3 to 5 reverse stitches have been sewn, release  (reverse/reinforcement stitch button).

► The machine stops sewing.

- 8** Press  (start/stop button), or press down on the foot controller.

At this time, if the start/stop button is held pressed, the machine sews at a low speed.

► The machine starts sewing in the normal sewing direction.

- 9** After sewing to the end of the stitching, the sewing machine stops.

Release the start/stop button or foot controller.

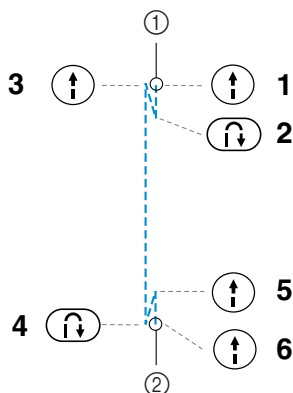

- ① Beginning of stitching  
② End of stitching

### ■ Sewing reinforcement stitches

When sewing stitches other than straight or zigzag stitches that are secured with reverse stitching, pressing  (reverse/reinforcement stitch button) sews reinforcement stitches, 3 to 5 stitches on top of each other.

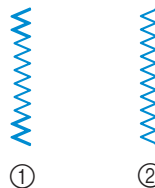

- ① Reverse stitching  
② Reinforcement stitching



### Memo

- Whether reverse stitches or reinforcement stitches are sewn depends on the stitch that is selected. For details, refer to “Stitch Settings” (page 128).

## Cutting the thread

When you have finished sewing, cut the threads. The threads can be cut in either of two ways.

### ■ Using the thread cutter button

- ① When you wish to finish the stitching, press  (thread cutter button) once.

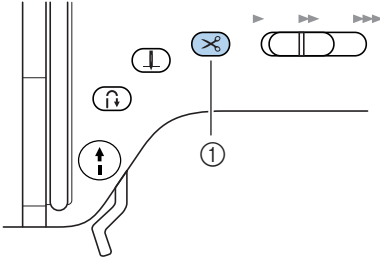

① Thread cutter button

▶ The threads are cut and the needle is raised.

- ② Raise the presser foot lever.

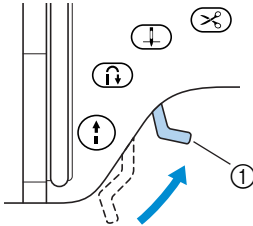

① Presser foot lever

## ! CAUTION

- Do not press the thread cutter button after the threads have already been cut, otherwise the needle may break, the threads may become tangled or damage to the machine may occur.



### Note

- Do not press the thread cutter button if there is no fabric under the presser foot or while the machine is sewing, otherwise damage to the machine may occur.



### Memo

- The machine can be set so that the threads will be cut when sewing is finished. For details on setting the machine so that the threads are cut automatically, refer to “Automatically cutting the thread” (page 58).

### ■ Using the manual thread cutter

When sewing with thread thicker than #30, nylon or metallic threads, or other special threads, use the thread cutter on the side of the machine to cut the threads.

- ① When you wish to finish the stitching and the sewing machine is stopped, press  (needle position button) once to raise the needle.

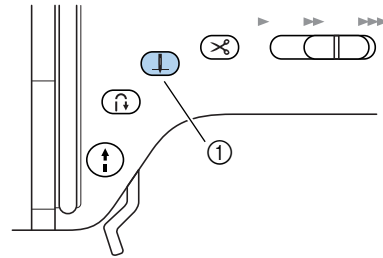

① Needle position button

▶ The needle is raised.

- ② Raise the presser foot lever.

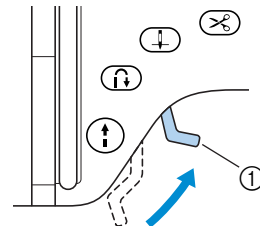

① Presser foot lever

- ③ Pull the fabric to the left side of the machine, and then pass the threads through the thread cutter to cut them.

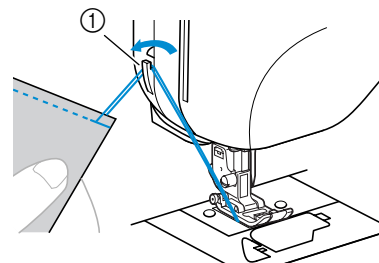

① Thread cutter

## Adjusting the Thread Tension

The tensions of the upper thread and of the bobbin thread (thread tension) should be adjusted so that they are equal.

### Changing the tension of the upper thread

If the thread and needle combination is correct for the type of fabric being sewn (according to “Needle types and their uses” on page 33), the thread tension will automatically be adjusted to the appropriate setting. However, if the preset thread tension does not give the desired result or if you are sewing with special thread or on special fabric, use the thread tension dial under the upper cover to adjust the tension of the upper thread.

#### ■ Correct thread tension

The upper thread and the bobbin thread should cross near the center of the fabric. Only the upper thread should be visible from the right side of the fabric, and only the bobbin thread should be visible from the wrong side of the fabric.

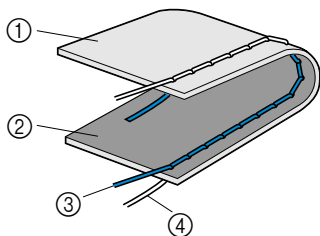

- ① Wrong side of fabric
- ② Right side of fabric
- ③ Upper thread
- ④ Bobbin thread

#### ■ Upper thread is too tight

If the bobbin thread is visible from the right side of the fabric, the upper thread is too tight.

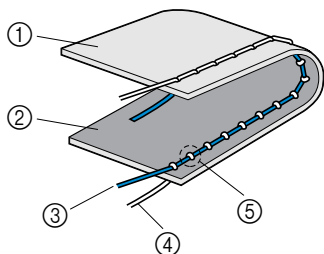

- ① Wrong side of fabric
- ② Right side of fabric
- ③ Upper thread
- ④ Bobbin thread
- ⑤ The bobbin thread is visible from the right side of the fabric.

Turn the thread tension dial to the left to loosen the upper thread.

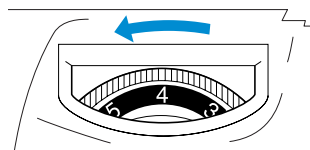

#### ■ Upper thread is too loose

If the upper thread is visible from the wrong side of the fabric, the upper thread is too loose.

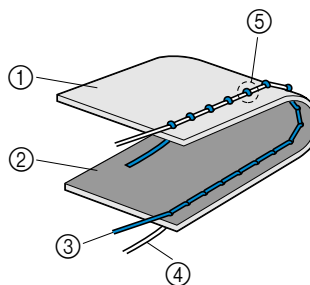

- ① Wrong side of fabric
- ② Right side of fabric
- ③ Upper thread
- ④ Bobbin thread
- ⑤ The upper thread is visible from the wrong side of the fabric.

Turn the thread tension dial to the right to tighten the upper thread.

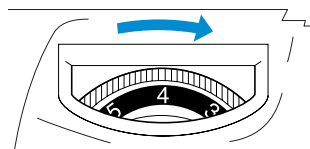

## Adjusting the Stitch Width and Length

The zigzag width (pattern width) and stitch length of utility stitches can be adjusted. Normally, when a stitch is selected, the appropriate width and length are automatically selected. For details on the range of values within which the width and length can be set, refer to “Stitch Settings” (page 128).

### Adjusting the stitch width

The stitch width can be adjusted with the arrow keys.

#### 1 Turn on the sewing machine.

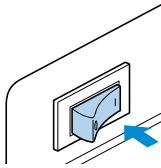

► The LCD comes on.

#### 2 Select a stitch.

► A screen containing settings for the selected stitch appears.



- For details on selecting a stitch, refer to “Selecting stitching” (page 68).
- Immediately after the stitch is selected, the standard settings (highlighted) appear.

#### 3 To make the stitch width narrower, press ◀ (-). To make the stitch width wider, press ▶ (+).

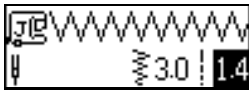

► The stitch width is changed.

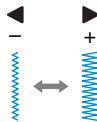

- If the setting is changed, the highlighted value is erased.

### Memo

- To reset the stitch width to its standard setting, select the same stitch again or change the setting to the highlighted value.
- If the straight stitch (left needle position or triple stretch stitch) was selected, changing the stitch width changes the needle position. Increasing the width moves the needle to the right; reducing the width moves the needle to the left.
- The settings can be saved so that they will always be specified each time the utility stitch is selected. For details, refer to “Saving stitch settings” (page 60).
- The sewing machine can be set so that the stitch width can easily be changed with the sewing speed controller. For details, refer to “Satin stitching” (page 99).

### CAUTION

- After adjusting the stitch width, slowly turn the balance wheel toward you and check that the needle does not touch the presser foot. If the needle hits the presser foot, the needle may bend or break.

## Adjusting the stitch length

The stitch length can be adjusted with the arrow keys.

### 1 Turn on the sewing machine.

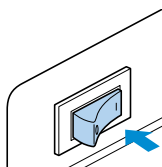

- ▶ The LCD comes on.

### 2 Select a stitch.

- ▶ A screen containing settings for the selected stitch appears.



- For details on selecting a stitch, refer to “Selecting stitching” (page 68).
- Immediately after the stitch is selected, the standard settings (highlighted) appear.

### 3 To make the stitch length shorter, press ▼ (-). To make the stitch length longer, press ▲ (+).



- ▶ The stitch length is changed.

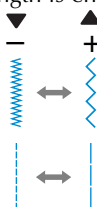

- If the setting is changed, the highlighted value is erased.

### Memo

- To reset the stitch length to its standard setting, select the same stitch again or change the setting to the highlighted value.
- The settings can be saved so that they will always be specified each time the utility stitch is selected. For details, refer to “Saving stitch settings” (page 60).

### CAUTION

- If the stitches are bunched together, increase the stitch length. Continuing to sew with the stitches bunched together may result in the needle bending or breaking.

## Useful Functions

Functions useful in improving sewing efficiency are described below.

### Automatically sewing reverse/reinforcement stitches

The sewing machine can be set to automatically sew reverse or reinforcement stitches at the beginning and end of the stitching.

Whether reverse stitches or reinforcement stitches are sewn depends on the stitch that is selected. For details, refer to “Stitch Settings” (page 128).

#### 1 Turn on the sewing machine.

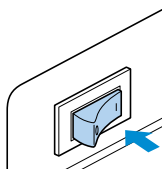

▶ The LCD comes on.

#### 2 Select a stitch.

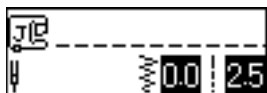

• For details on selecting a stitch, refer to “Selecting stitching” (page 68).

#### 3 Press (settings key) in the operation panel.

▶ The settings screen appears.

#### 4 Press , , and (arrow keys) until is selected.



#### 5 Press (OK key).

▶ The screen for specifying automatic reverse/reinforcement stitching appears.

#### 6 Press to select . To return to , press .

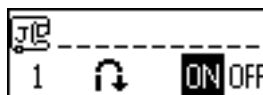

▶ The machine is now set to automatically sew reverse/reinforcement stitches.

#### 7 Press (OK key).

▶ The initial stitch screen appears again, and  appears in the lower-left corner of the screen.

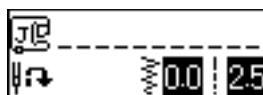

• When the sewing machine is turned off, the automatic reverse/reinforcement stitching setting is cancelled.

#### 8 Position the fabric under the presser foot, and then press (start/stop button) once.

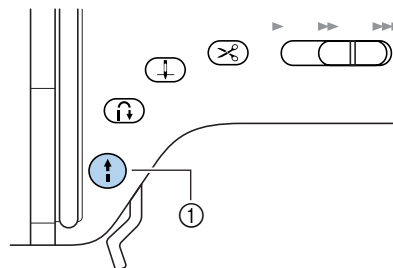

① Start/stop button

▶ After reverse/reinforcement stitches are sewn, the machine starts sewing.

- 9** After reaching the end of the stitching, press  (reverse/reinforcement stitch button) once.

This step is not necessary if a stitch such as those for sewing buttonholes and bar tacks is selected where reinforcement stitches are automatically sewn.

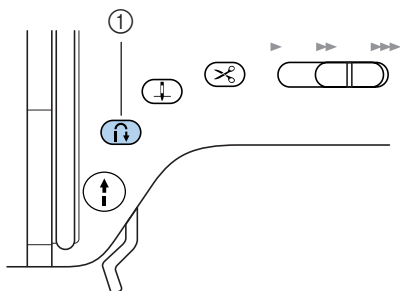

① Reverse/reinforcement stitch button

- After reverse/reinforcement stitches are sewn, the sewing machine stops.

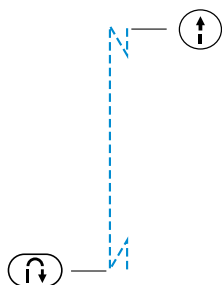

### Memo

- Reverse/reinforcement stitches will not be sewn if the start/stop button is pressed at the end of the stitching. Be sure to press the reverse/reinforcement stitch button at the end of the stitching.

## Automatically cutting the thread

The sewing machine can be set to automatically cut the threads at the end of the stitching. This is called “programmed thread-cutting”.

If programmed thread-cutting is set, automatic reverse/reinforcement stitching is also set. This setting is convenient if a stitch for sewing buttonholes or bar tacks is selected.

- 1** Turn on the sewing machine.

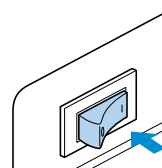

- The LCD comes on.

- 2** Select a stitch.

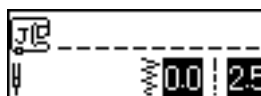

- For details on selecting a stitch, refer to “Selecting stitching” (page 68).

- 3** Press  (settings key) in the operation panel.

- The settings screen appears.

- 4** Press , ,  and  (arrow keys) until  is selected.



- 5** Press  (OK key).

- The screen for specifying automatic thread-cutting appears.



- 6** Press ◀ to select ON. To return to OFF, press ▶.

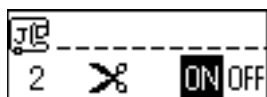

- ▶ The machine is now set for programmed thread-cutting.

- 7** Press OK (OK key).

- ▶ The initial stitch screen appears again, and the scissors icon appears in the lower-left corner of the screen.



- When the sewing machine is turned off, the programmed thread-cutting setting is cancelled.

- 8** Position the fabric under the presser foot, and then press ⏪ (start/stop button) once.

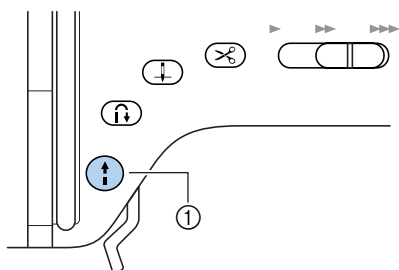

- ① Start/stop button

- ▶ After reverse/reinforcement stitches are sewn, the machine starts sewing.

- 9** After reaching the end of the stitching, press ⏩ (reverse/reinforcement stitch button) once.

This step is not necessary if a stitch such as those for sewing buttonholes and bar tacks is selected where reinforcement stitches are automatically sewn.

- ▶ After reverse/reinforcement stitches are sewn, the sewing machine stops and cuts the thread.

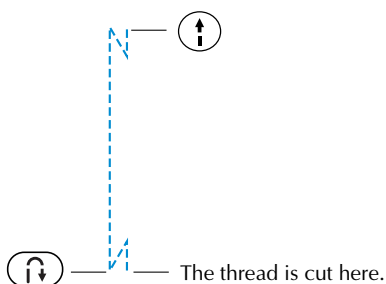

### Memo

- Reverse/reinforcement stitches will not be sewn and the thread will not automatically be cut if the start/stop button is pressed at the end of the stitching. Be sure to press the reverse/reinforcement stitch button at the end of the stitching.

## Saving stitch settings

Adjusted stitch width and length settings can be saved so that they will be specified each time the stitch is selected. The various settings can be saved for each utility stitch.

### 1 Select the stitch, and then adjust the stitch width and length.

To adjust the stitch width, press ◀ (-) and ▶ (+). To adjust the stitch length, press ▼ (-) and ▲ (+).

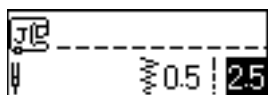

- For details on selecting a stitch, refer to “Selecting stitching” (page 68).
- ▶ The stitch width and length are changed.

### 2 Press (settings key) in the operation panel.

▶ The settings screen appears.

### 3 Press ▲, ▼, ◀ and ▶ (arrow keys) until

 is selected.



### 4 Press (OK key).



▶ The screen for saving the settings appears.

### 5 Check the is selected, and then press

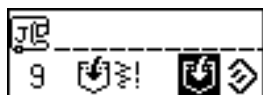
 (OK key).



▶ The settings for the stitch width and length are saved.

- The next time that the stitch is selected, the saved settings are the first ones that are displayed.
- To clear the saved settings and return the stitch width and length to their default settings, press ▶ so that , and then press  (OK key).

## Hands-free raising and lifting of the presser foot

Using the knee lifter, you can raise and lower the presser foot with your knee, leaving both hands free to handle the fabric.



### ■ Installing the knee lifter

- 1 Turn off the sewing machine.

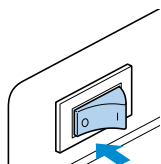

- 2 Insert the knee lifter into its jack on the front of the sewing machine in the lower-right corner.

Align the tabs on the knee lifter with the notches in the jack, and then insert the knee lifter as far as possible.

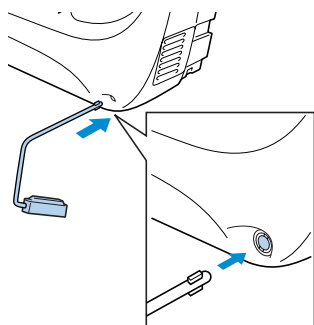

### Note

- If the knee lifter is not fully inserted into its jack, it may fall out while the sewing machine is operating.

### ■ Using the knee lifter

- 1 Stop the sewing machine.
  - Do not use the knee lifter while the sewing machine is operating.
- 2 With your knee, press the knee lifter to the right.  
Keep the knee lifter pressed to the right.

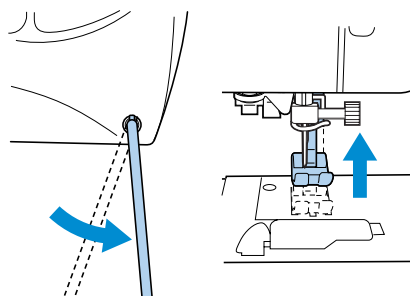

► The presser foot is raised.

- 3 Release the knee lifter.  
► The presser foot is lowered.

### ! CAUTION

- While sewing, keep your knee away from the knee lifter. If the knee lifter is pressed while the sewing machine is operating, the needle may break or the machine may be damaged.

## Useful Sewing Tips

Various ways to achieve better results for your sewing projects are described below. Refer to these tips when sewing your project.

### Trial sewing

After you have set up the machine with the thread and needle appropriate for the type of fabric being sewn, the machine automatically sets the thread tension and stitch length and width for the stitch that is selected. However, a trial piece of fabric should be sewn since, depending on the type of fabric and stitching being sewn, the desired results may not be achieved.

For the trial sewing, use a piece of fabric and thread that are the same as those used for your project, and check the thread tension and stitch length and width. Since the results differ depending on the type of stitching and the number of layers of fabric sewn, perform the trial sewing under the same conditions that will be used with your project.

### Changing the sewing direction

#### 1 When the stitching reaches a corner, stop the sewing machine.

Leave the needle lowered (in the fabric). If the needle remained up when the machine stopped sewing, press  (needle position button) to lower the needle.

#### 2 Raise the presser foot lever, and then turn the fabric.

Turn the fabric using the needle as a pivot.

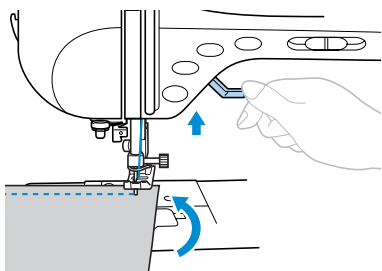

#### 3 Lower the presser foot lever and continue sewing.

### Sewing curves

Stop sewing, and then slightly change the sewing direction to sew around the curve. For details on sewing with an even seam allowance, refer to “Sewing an even seam allowance” (page 64).

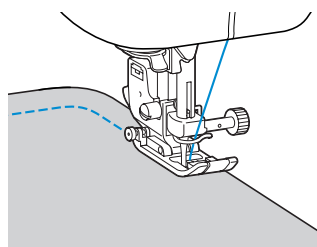

When sewing along a curve while using a zigzag stitch, select a shorter stitch length in order to obtain a finer stitch.

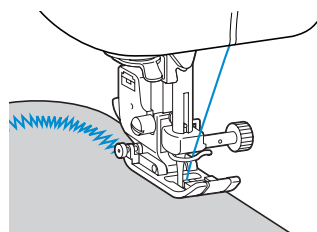

## Sewing thick fabrics

- **If the fabric does not fit under the presser foot**  
If the fabric does not fit easily under the presser foot, raise the presser foot lever even higher to bring the presser foot to its highest position.

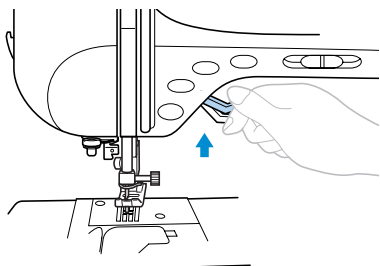

- **If thick seams are being sewn and the fabric does not feed at the beginning of stitching**  
Zigzag foot "J" is equipped with a feature that keeps the presser foot level.

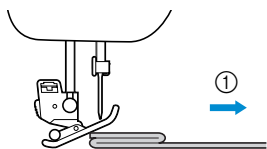

① Sewing direction

- ① **When you encounter a seam that is too thick to feed under the foot, raise the presser foot lever.**
- ② **Press the black button on the left side of the foot. Keep the button held in and lower the presser foot.**

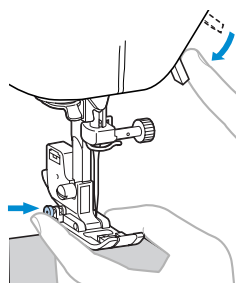

- ③ **Release the button. The foot will lock in place level with the seam, allowing the fabric to feed.**

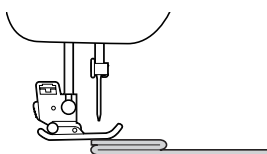

- Once the trouble spot has been passed, the foot will return to its normal position.

## CAUTION

- **If fabric more than 6 mm (15/64 inch) thick is sewn or if the fabric is pushed with too much force, the needle may bend or break.**

## Sewing thin fabrics

When sewing thin fabrics, the stitching may become misaligned or the fabric may not feed correctly. If this occurs, place thin paper or stabilizer material under the fabric and sew it together with the fabric. When you have finished sewing, tear off any excess paper.

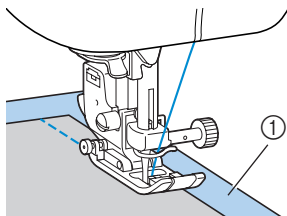

① Stabilizer material or paper

## Sewing stretch fabrics

First, baste the pieces of fabric together, and then sew without stretching the fabric.

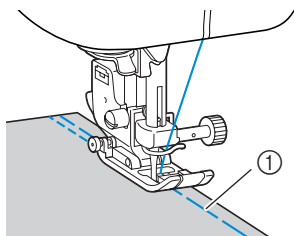

① Basting

## Sewing leathers or vinyl fabrics

When sewing the fabrics that may stick to the presser foot such as leathers or coated fabrics, change the presser foot to the non stick foot.

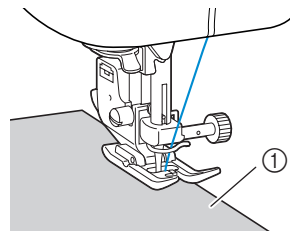

① Leather

## Sewing an even seam allowance

To sew an even seam, start sewing so that the seam allowance is to the right of the presser foot, and the edge of the fabric is aligned with either the right edge of the presser foot or a marking on the needle plate.

### ■ Aligning the fabric with the presser foot

Sew while keeping the right edge of the presser foot a fixed distance from the edge of the fabric.

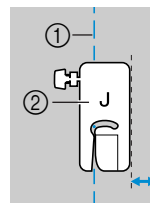

① Seam  
② Presser foot

### ■ Aligning the fabric with the stitch guide foot

Sew while keeping the right edge of the fabric aligned with a desired position of markings on the stitch guide foot.

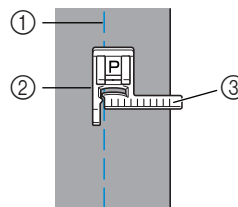

① Seam  
② Stitch guide foot  
③ Markings

## ■ Aligning the fabric with a needle plate marking

The markings on the needle plate show the distance from the needle position of a seam sewn with the straight stitch (left needle position). Sew while keeping the edge of the fabric aligned with a marking in the needle plate. The distance between the markings in the upper scale is 1/8 inch (3 mm) and the distance between the markings in the grid is 5 mm (3/16 inch).

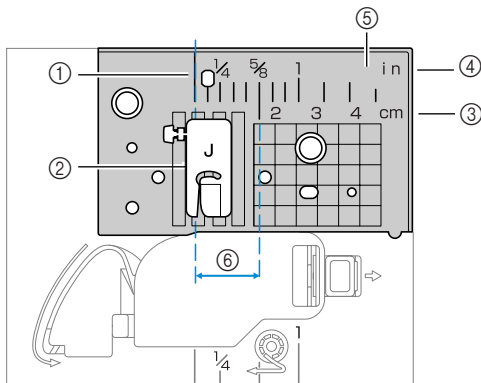

- ① Seam
- ② Presser foot
- ③ Centimeters
- ④ Inches
- ⑤ Needle plate
- ⑥ 16 mm (5/8 inch)

CONTENTS

GETTING READY

SEWING BASICS

UTILITY STITCHES

APPENDIX

INDEX



## 3

**UTILITY STITCHES**

The various stitches and their applications are described in this chapter.

Selecting Stitching .....	68
Overcasting Stitches .....	70
Basic Stitching .....	74
Blind Hem Stitching .....	76
Buttonhole Stitching .....	78
Zipper Insertion .....	85
Zipper/piping Insertion .....	89
Sewing Stretch Fabrics and Elastic Tape .....	91
Appliqué, Patchwork and Quilt Stitching .....	93
Reinforcement Stitching .....	100
Eyelet Stitching .....	104
Decorative Stitching .....	105
Sewing the Various Built-In Decorative Patterns .....	113
Designing a Pattern .....	123

## Selecting Stitching

You can select any of the various types of stitching available.

### Stitch types

A total of 8 groups of stitch types (utility stitches, decorative stitches, satin stitches, cross-stitches, decorative satin stitches and 3 types of character stitches) are available.

For details on the types of stitches available, refer to “Stitch Settings” (page 128).

#### ■ Utility stitches

There are 67 utility stitches, including straight stitches, overcasting stitches and buttonhole stitches.

#### ■ Decorative stitches

There are 31 decorative stitches, including hearts, leaves and flowers.

#### ■ Satin stitches

There are 16 satin stitches.

#### ■ Cross-stitches

There are 5 types of cross-stitches.

#### ■ Decorative satin stitches

There are 10 decorative satin stitches.

#### ■ Character stitch—Gothic font

There are 55 characters, including letters, symbols and numbers, in the Gothic font.

#### ■ Character stitch—Script font

There are 55 characters, including letters, symbols and numbers, in the Script font.

#### ■ Character stitch—Outline style

There are 55 characters, including letters, symbols and numbers, in the outline style.

### Selecting stitching

Using the operation panel keys, select the desired stitch from those shown in the LCD. Twelve of the most often used utility stitches can quickly be selected with the stitch keys.

When the sewing machine is turned on, the straight stitch (left needle position) is selected.

- 1 **Determine the stitch that you wish to use.**
  - Refer to “Stitch types” (at the left).
- 2 **Determine which presser foot should be used with the selected stitch.**

The presser feet are stored in the accessory compartment.

  - For details on the stitches that can be sewn with the twin needle, refer to “Stitch Settings” (page 128).
- 3 **Attach the presser foot.**
  - For details, refer to “Replacing the presser foot” (page 37).
- 4 **Turn on the sewing machine.**

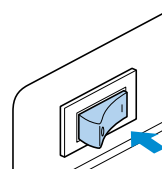

- ▶ The straight stitch (left needle position) is shown selected in the LCD.

- 5 **Press  (stitch selection key) in the operation panel.**

To select a stitch using the stitch keys, press the key of the desired stitch.

Continue with step 10.

- ▶ The screen containing the various types of stitches appears.

- 6** Press ▲, ▼, ◀ and ▶ (arrow keys) until the type of stitch that you wish to use is selected.

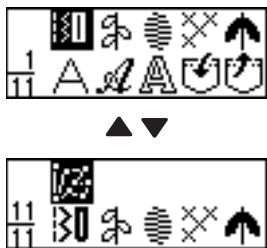

- 7** Press **OK** (OK key).
- ▶ The screen containing the various stitches in the selected stitch type appears.

■ Understanding the screen

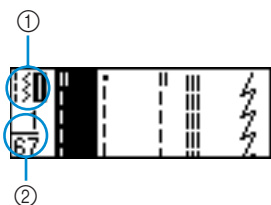

- ① Selected stitch type
  - ② Number of stitches in the selected stitch type
- To select a different stitch type, press ↶ (back key).

- 8** Press ▲, ▼, ◀ and ▶ (arrow keys) until the stitch that you wish to use is selected.
- Press ▲ to return to the previous screen.  
Press ▼ to display the next screen.

- 9** Press **OK** (OK key).
- ▶ The stitch is selected.

- 10** If necessary, specify the setting for automatic reverse/reinforcement stitching and adjust the stitch length, etc.
- For details on sewing with each of the utility stitches, refer to the following pages.

 **Note**

- When a stitch is selected, the icon for the presser foot that should be used appears in the screen. Check that the correct presser foot is attached before starting to sew. If the wrong presser foot is installed, turn off the sewing machine, attach the correct presser foot, and then select the desired stitch again.

 **Memo**

- For details on adjusting the stitch width and length, refer to “Adjusting the Stitch Width and Length” (page 55).

# Overcasting Stitches

Sew overcasting stitches along the edges of cut fabric to prevent them from fraying. Fifteen stitches are available for overcasting. The procedure for sewing overcasting stitch is explained according to the presser foot that is used.

## Sewing overcasting stitches using overcasting foot “G”

Three stitches can be used to sew overcasting with overcasting foot “G”.

Stitch Name	Pattern	Stitch Key	Application	Stitch Width [mm (inch.)]		Stitch Length [mm (inch.)]		Presser Foot
				Auto	Manual	Auto	Manual	
Overcasting stitch	11		Preventing fraying in medium weight and thin fabrics	3.5 (1/8)	2.5–5.0 (3/32–3/16)	2.0 (1/16)	1.0–4.0 (1/16–3/16)	G
	12		Preventing fraying in thick fabrics and fabrics that fray easily	5.0 (3/16)	2.5–5.0 (3/32–3/16)	2.5 (3/32)	1.0–4.0 (1/16–3/16)	
	13	—		5.0 (3/16)	3.5–5.0 (1/8–3/16)	2.5 (3/32)	1.0–4.0 (1/16–3/16)	

**1** Attach overcasting foot “G”.

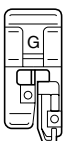

- For details, refer to “Replacing the presser foot” (page 37).

**2** Select a stitch.

- For details, refer to “Selecting stitching” (page 68).

**3** Position the fabric with the edge of the fabric against the guide of the presser foot, and then lower the presser foot lever.

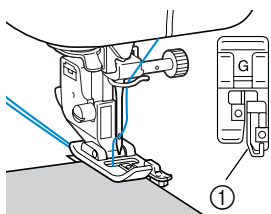

① Guide

**4** Sew with the edge of the fabric against the presser foot guide.

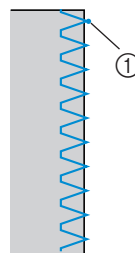

① Needle drop point

**! CAUTION**

- After adjusting the stitch width, slowly turn the balance wheel toward you and check that the needle does not touch the presser foot. If the needle hits the presser foot, the needle may bend or break.

## Sewing overcasting stitches using zigzag foot “J”

Seven stitches can be used to sew overcasting stitches with zigzag foot “J”.

Stitch Name	Pattern	Stitch Key	Application	Stitch Width [mm (inch.)]		Stitch Length [mm (inch.)]		Presser Foot
				Auto	Manual	Auto	Manual	
Zigzag stitch (center needle position)	7		Preventing fraying (center baseline/reverse stitching)	3.5 (1/8)	0.0–7.0 (0–1/4)	1.4 (1/16)	0.0–4.0 (0–3/16)	J
Zigzag stitch (right needle position)	8	–	Preventing fraying (right baseline/reinforcement stitching)	3.5 (1/8)	2.5–5.0 (3/32–3/16)	1.4 (1/16)	0.3–4.0 (1/64–3/16)	
2-point zigzag stitch	9	–	Preventing fraying in thick fabrics and stretch fabrics	5.0 (3/16)	1.5–7.0 (1/16–1/4)	1.0 (1/16)	0.2–4.0 (1/64–3/16)	
3-point zigzag stitch	10			5.0 (3/16)	1.5–7.0 (1/16–1/4)	1.0 (1/16)	0.2–4.0 (1/64–3/16)	
Overcasting stitch	14	–	Preventing fraying in stretch fabrics	5.0 (3/16)	0.0–7.0 (0–1/4)	2.5 (3/32)	0.5–4.0 (1/32–3/16)	
	15	–	Preventing fraying in thick fabrics and stretch fabrics	5.0 (3/16)	0.0–7.0 (0–1/4)	2.5 (3/32)	0.5–4.0 (1/32–3/16)	
	16	–	Preventing fraying in stretch fabrics	4.0 (3/16)	0.0–7.0 (0–1/4)	4.0 (3/16)	1.0–4.0 (1/16–3/16)	

### 1 Attach zigzag foot “J”.

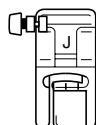

- For details, refer to “Replacing the presser foot” (page 37).

### 2 Select a stitch.

- For details, refer to “Selecting stitching” (page 68).

### 3 Sew along the edge of the fabric with the needle dropping off the edge at the right.

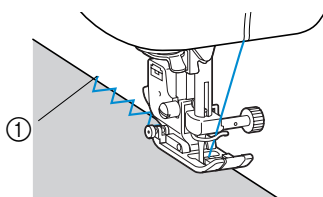

- ① Needle drop point

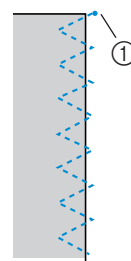





- ① Needle drop point

### Memo

- For best results when sewing stretch fabrics, decrease the pressure of the presser foot. For details, refer to “Adjusting the pressure of the presser foot” (page 39).

## Sewing overcasting stitches using the optional side cutter

Using the side cutter, seam allowances can be finished while the edge of the fabric is cut off. Five stitches can be used to sew overcasting stitches with the side cutter.

Stitch Name	Pattern	Application	Stitch Width [mm (inch.)]		Stitch Length [mm (inch.)]		Presser Foot
			Auto	Manual	Auto	Manual	
Overcasting stitch	63 	Sewing straight stitches while cutting the fabric	0.0 (0)	0.0–2.5 (0–3/32)	2.5 (3/32)	0.2–5.0 (1/64–3/16)	S
	64 	Sewing zigzag stitches while cutting the fabric	3.5 (1/8)	3.5–5.0 (1/8–3/16)	1.4 (1/16)	0.0–4.0 (0–3/16)	
	65 	Preventing fraying in thin and mediumweight fabrics while cutting the fabric	3.5 (1/8)	3.5–5.0 (1/8–3/16)	2.0 (1/16)	1.0–4.0 (1/16–3/16)	
	66 	Preventing fraying in thick fabrics while cutting the fabric	5.0 (3/16)	3.5–5.0 (1/8–3/16)	2.5 (3/32)	1.0–4.0 (1/16–3/16)	
	67 	Preventing fraying in thick fabrics while cutting the fabric	5.0 (3/16)	3.5–5.0 (1/8–3/16)	2.5 (3/32)	1.0–4.0 (1/16–3/16)	

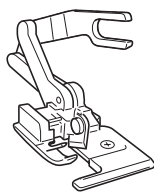

- 1 Remove the presser foot.**
  - For details, refer to “Replacing the presser foot” (page 37).
- 2 Lower the presser foot lever, and then manually thread the needle.**
  - The needle threader cannot be used. If the needle threader is used with the side cutter, the sewing machine may be damaged.
- 3 Raise the presser foot lever.**

- 4 Hook the connecting fork of the side cutter onto the needle clamp screw.**

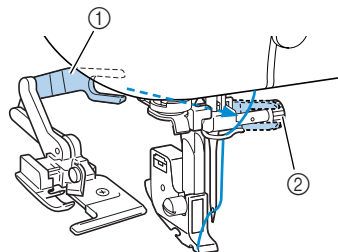

- ① Connecting fork
- ② Needle clamp screw

- 5 Position the side cutter so that side cutter pin is aligned with the notch in the presser foot holder, and then slowly lower the presser foot lever.**

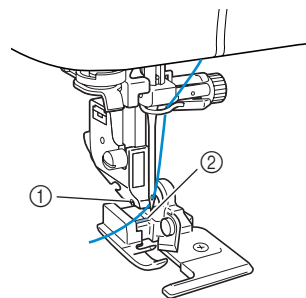

- ① Notch in presser foot holder
- ② Pin

► The side cutter is attached.

**6** Raise the presser foot lever to check that the side cutter is securely attached.

**7** Pass the upper thread under the side cutter, and then pull it out toward the rear of the sewing machine.

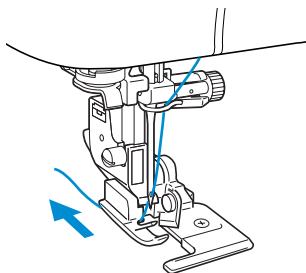

**8** Select a stitch.  
• For details, refer to “Selecting stitching” (page 68).

### ! CAUTION

- After adjusting the stitch width, slowly turn the balance wheel toward you and check that the needle does not touch the presser foot. If the needle hits the presser foot, the needle may bend or break.

**9** Make a cut of about 2 cm (1/16 inch) long in the fabric at the beginning of the stitching.

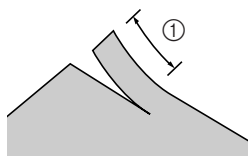

① 2 cm (1/16 inch)

**10** Position the fabric in the side cutter. The cut in the fabric should be positioned over the guide plate of the side cutter.

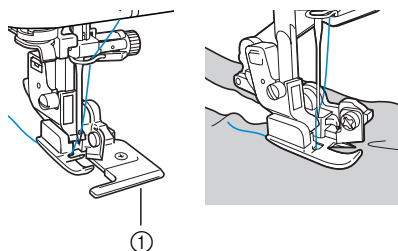

① Guide plate

- If the fabric is not positioned correctly, the fabric will not be cut.

**11** Lower the presser foot lever, and then start sewing.

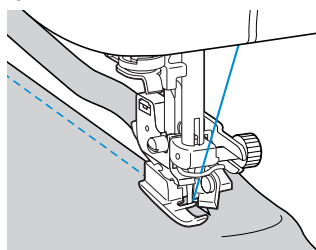

▶ A seam allowance is cut while the stitching is sewn.

- If the stitching is sewn in a straight line, the seam allowance will be about 5 mm (3/16 inch).

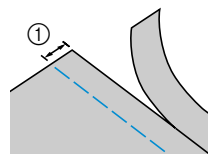

① 5 mm (3/16 inch)

### 🔔 Memo

- The side cutter can cut as much as one layer of 13-oz. denim.
- After using the side cutter, clean it by removing any lint or dust.
- If the side cutter can no longer cut fabric, use a rag to apply a small amount of oil to the cutting edge of the cutter.
- The optional side cutter is available through your brother retailer.

# Basic Stitching

Straight stitches are used for sewing plain seams. Five stitches are available for basic stitching.

Stitch Name	Pattern	Stitch Key	Application	Stitch Width [mm (inch.)]		Stitch Length [mm (inch.)]		Presser Foot
				Auto	Manual	Auto	Manual	
Basting stitch	6	—	Temporarily securing	0.0 (0)	0.0–7.0 (0–1/4)	—	—	J
Straight stitch (left needle position)	1		Basic stitching and sewing gathers or pintucks (left baseline/reverse stitching)	0.0 (0)	0.0–7.0 (0–1/4)	2.5 (3/32)	0.2–5.0 (1/64–3/16)	
	2	—	Basic stitching and sewing gathers or pintucks (left baseline/reinforcement stitching)	0.0 (0)	0.0–7.0 (0–1/4)	2.5 (3/32)	0.2–5.0 (1/64–3/16)	
Straight stitch (center needle position)	3		Basic stitching and sewing gathers or pintucks (center baseline/reverse stitching)	—	—	2.5 (3/32)	0.2–5.0 (1/64–3/16)	
Triple stretch stitch	4		Reinforcing seams and sewing stretch fabrics	0.0 (0)	0.0–7.0 (0–1/4)	2.5 (3/32)	1.5–4.0 (1/16–3/16)	

## Basting

Sew basting with a stitch length of 5 mm (3/16 inch).

- 1 Attach zigzag foot “J”.

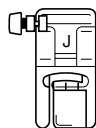

- For details, refer to “Replacing the presser foot” (page 37).

- 2 Select stitch 6 | | .

- For details, refer to “Selecting stitching” (page 68).

- 3 Start sewing.

- For details, refer to “Starting to sew” (page 49).

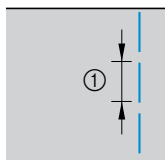

① 5 mm (3/16 inch)

## Basic stitching

- 1 Baste or pin together the fabric pieces.

- 2 Attach zigzag foot “J”.

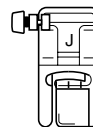

- For details, refer to “Replacing the presser foot” (page 37).

- 3 Select a stitch.

- For details, refer to “Selecting stitching” (page 68).

- 4 Lower the needle into the fabric at the beginning of the stitching.



## 5 Start sewing.

- For details, refer to “Starting to sew” (page 49).
- For details on sewing reverse/reinforcement stitches, refer to “Securing the stitching” (page 51).

## 6 When sewing is finished, cut the thread.

- For details, refer to “Cutting the thread” (page 53).



## Changing the needle position

The needle position used as the baseline is different for the straight stitch (left needle position) and the straight stitch (center needle position).

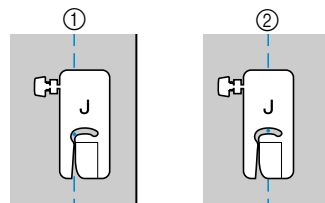

- ① Straight stitch (left needle position)
- ② Straight stitch (center needle position)

When the stitch width of the straight stitch (left needle position) is set to its standard setting (0.0 mm), the distance from the needle position to the right side of the presser foot is 12 mm (1/2 inch). If the stitch width is changed (between 0 and 7 mm (1/4 inch)), the needle position will also change. By changing the stitch width and sewing with the right side of the presser foot aligned with the edge of the fabric, a seam allowance can be sewn with a fixed width.

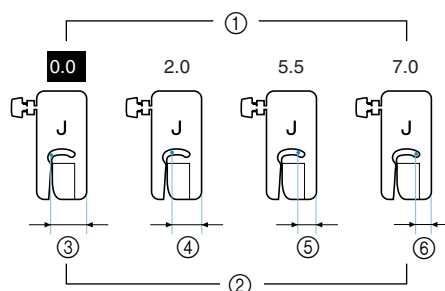

- ① Stitch width
- ② Distance from the needle position to the right side of the presser foot
- ③ 12.0 mm (1/2 inch)
- ④ 10.0 mm (3/8 inch)
- ⑤ 6.5 mm (1/4 inch)
- ⑥ 5.0 mm (3/16 inch)

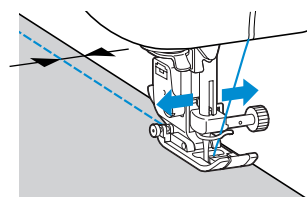

- For details, refer to “Adjusting the stitch width” (page 55).

# Blind Hem Stitching

Secure the bottoms of skirts and pants with a blind hem. Two stitches are available for blind hem stitching.

Stitch Name	Pattern	Stitch Key	Application	Stitch Width [mm (inch.)]		Stitch Length [mm (inch.)]		Presser Foot
				Auto	Manual	Auto	Manual	
Blind hem stitch	17		Blind hem stitching on mediumweight fabrics	0.0 (0)	3← - 3→	2.0 (1/16)	1.0-3.5 (1/16-1/8)	R
	18		Blind hem stitching on stretch fabrics	0.0 (0)	3← - 3→	2.0 (1/16)	1.0-3.5 (1/16-1/8)	R

Sew a blind hem according to the following procedure.

- 1** Fold the fabric along the desired edge of the hem, and then baste it about 5 mm (3/16 inch) from the edge of the fabric.

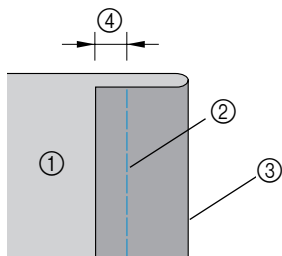

- ① Wrong side of fabric
- ② Basting stitching
- ③ Desired edge of hem
- ④ 5 mm (3/16 inch)

- 2** Fold back the fabric along the basting, and then position the fabric with the wrong side facing up.

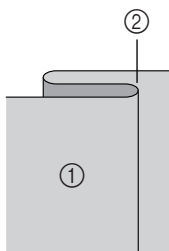

- ① Wrong side of fabric
- ② Basting

- 3** Attach blind hem foot “R”.

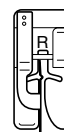

- For details, refer to “Replacing the presser foot” (page 37).

- 4** Select a stitch.
- For details, refer to “Selecting stitching” (page 68).

- 5** Position the fabric with the edge of the folded hem against the guide of the presser foot, and then lower the presser foot lever.

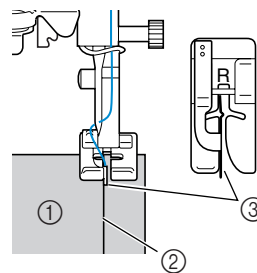

- ① Wrong side of fabric
- ② Fold of hem
- ③ Guide

**6 Adjust the stitch width until the needle slightly catches the fold of the hem.**

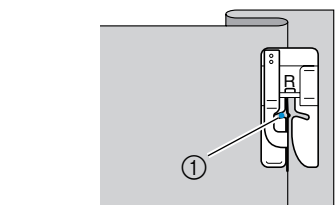

① Needle drop point

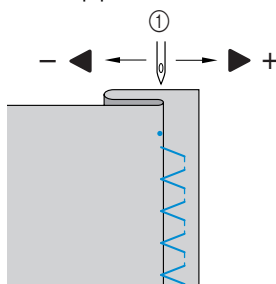

① Stitch width

**■ If the needle catches too much of the hem fold**

The needle is too far to the left. Press ► (of the arrow keys) to decrease the stitch width so that the needle slightly catches the fold of the hem.

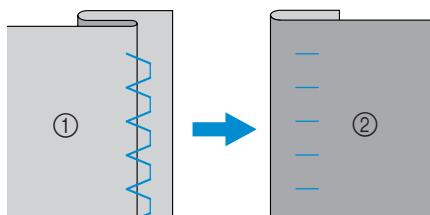

① Wrong side of fabric  
② Right side of fabric

**■ If the needle does not catch the hem fold**

The needle is too far to the right. Press ◀ (of the arrow keys) to increase the stitch width so that the needle slightly catches the fold of the hem.

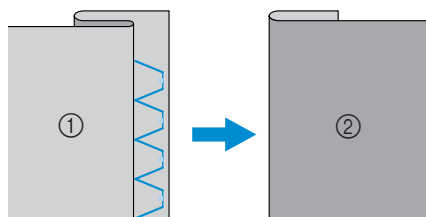

① Wrong side of fabric  
② Right side of fabric

• For details on changing the stitch width, refer to “Adjusting the Stitch Width and Length” (page 55).

**7 Sew with the fold of the hem against the presser foot guide.**

**8 Remove the basting stitching.**

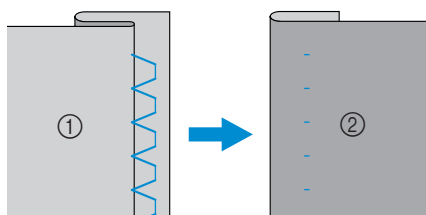

① Wrong side of fabric  
② Right side of fabric















**Memo**

• For best results when sewing stretch fabrics, decrease the pressure of the presser foot. For details, refer to “Adjusting the pressure of the presser foot” (page 39).

## Buttonhole Stitching

Buttonholes can be sewn and buttons can be sewn on. Eleven stitches are available for sewing on buttons and one-step buttonholes.

Stitch Name	Pattern	Stitch Key	Application	Stitch Width [mm (inch.)]		Stitch Length [mm (inch.)]		Presser Foot
				Auto	Manual	Auto	Manual	
Buttonhole stitch	42 	–	Horizontal buttonholes on thin and mediumweight fabrics	5.0 (3/16)	3.0–5.0 (1/8–3/16)	0.4 (1/64)	0.2–1.0 (1/64–1/16)	A
	43 	–	Horizontal buttonholes on areas that are subject to strain	5.0 (3/16)	3.0–5.0 (1/8–3/16)	0.4 (1/64)	0.2–1.0 (1/64–1/16)	
	44 	–	Horizontal buttonholes on thick fabrics	5.0 (3/16)	3.0–5.0 (1/8–3/16)	0.4 (1/64)	0.2–1.0 (1/64–1/16)	
	45 		Buttonholes with bar tacks on both ends for stabilized fabrics	5.0 (3/16)	3.0–5.0 (1/8–3/16)	0.4 (1/64)	0.2–1.0 (1/64–1/16)	
	46 	–	Buttonholes for stretch or knit fabrics	6.0 (15/64)	3.0–6.0 (1/8–15/64)	1.0 (1/16)	0.5–2.0 (1/32–1/16)	
	47 	–	Buttonholes for stretch fabrics	6.0 (15/64)	3.0–6.0 (1/8–15/64)	1.5 (1/16)	1.0–3.0 (1/16–1/8)	
	48 	–	Bound buttonholes	5.0 (3/16)	0.0–6.0 (0–15/64)	2.0 (1/16)	0.2–4.0 (1/64–3/16)	
	49 	–	Keyhole buttonholes for thick or plush fabrics	7.0 (1/4)	3.0–7.0 (1/8–1/4)	0.5 (1/32)	0.3–1.0 (1/64–1/16)	
	50 	–	Keyhole buttonholes for mediumweight and thick fabrics	7.0 (1/4)	3.0–7.0 (1/8–1/4)	0.5 (1/32)	0.3–1.0 (1/64–1/16)	
	51 	–	Horizontal buttonhole for thick or plush fabrics	7.0 (1/4)	3.0–7.0 (1/8–1/4)	0.5 (1/32)	0.3–1.0 (1/64–1/16)	
Button-sewing stitch	55 	–	Button sewing	3.5 (1/8)	2.5–4.5 (3/32–3/16)	–	–	M

## Buttonhole sewing

The maximum buttonhole length is about 28 mm (1-1/8 inch) (diameter + thickness of the button). Buttonholes are sewn from the front of the presser foot to the back, as shown below.

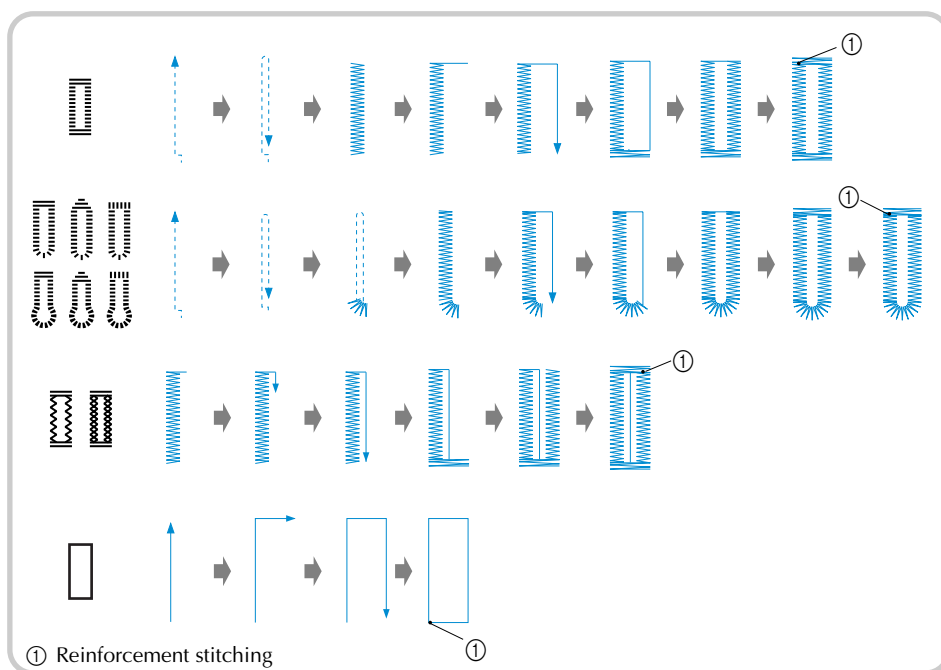

The names of parts of buttonhole foot “A”, which is used for sewing buttonholes, are indicated below.

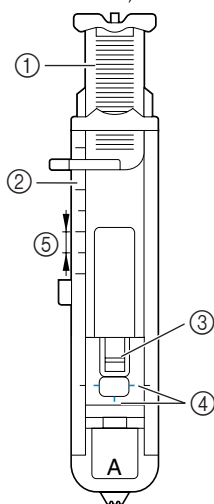

- ① Button guide plate
- ② Presser foot scale
- ③ Pin
- ④ Marks on buttonhole foot
- ⑤ 5 mm (3/16 inch)

- 1** Use chalk to mark on the fabric the position and length of the buttonhole.

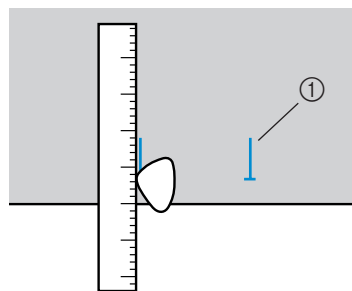

- ① Marks on fabric

- 2** Pull out the button guide plate of buttonhole foot “A”, and then insert the button that will be put through the buttonhole.

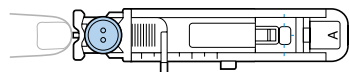

**■ If the button does not fit in the button guide plate**

Add together the diameter and thickness of the button, and then set the button guide plate to the calculated length. (The distance between the markings on the presser foot scale is 5 mm (3/16 inch).)

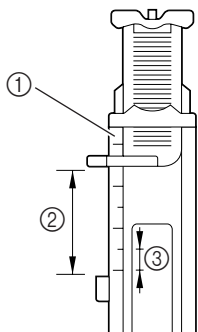

- ① Presser foot scale
- ② Length of buttonhole (Diameter + thickness of button)
- ③ 5 mm (3/16 inch)

Example: For a button with a diameter of 15 mm (9/16 inch) and a thickness of 10 mm (3/8 inch), the button guide plate should be set to 25 mm (1 inch) on the scale.

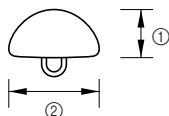

- ① 10 mm (3/8 inch)
- ② 15 mm (9/16 inch)

► The size of the buttonhole is set.

- 3 Attach buttonhole foot “A”.**
  - For details, refer to “Replacing the presser foot” (page 37).

- 4 Select a stitch.**
  - For details, refer to “Selecting stitching” (page 68).

- 5 Position the fabric with the front end of the buttonhole mark aligned with the red marks on the sides of the buttonhole foot, and then lower the presser foot lever.**

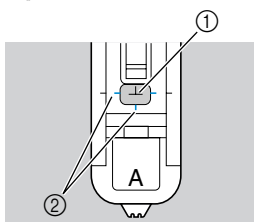

- ① Mark on fabric
- ② Red marks on buttonhole foot

Pass the upper thread down through the hole in the presser foot.

- When lowering the presser foot, do not push in the front of the presser foot, otherwise the buttonhole will not be sewn with the correct size.

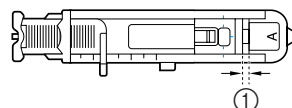
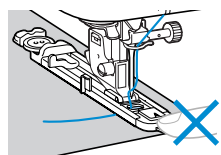

- ① Do not reduce the gap.

- 6 Pull down the buttonhole lever as far as possible.**

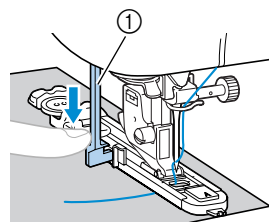

- ① Buttonhole lever

The buttonhole lever is positioned behind the bracket on the buttonhole foot.

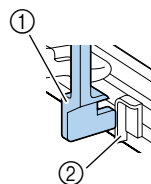

- ① Buttonhole lever
- ② Bracket

- 7 Gently hold the end of the upper thread in your left hand, and then start sewing.**

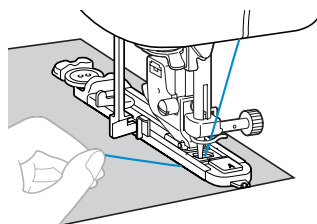

- Once sewing is completed, the machine automatically sews reinforcement stitches, then stops

- 8 Cut the threads, raise the presser foot lever, and then remove the fabric.**

9 Raise the buttonhole lever to its original position.

10 Insert a pin along the inside of one bar tack at the end of the buttonhole stitching to prevent the stitching from being cut.

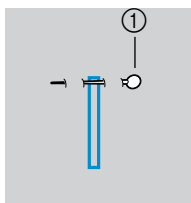

① Pin

11 Use the seam ripper to cut towards the pin and open the buttonhole.

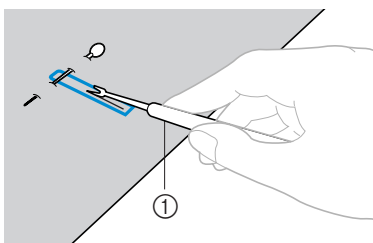

① Seam ripper

For keyhole buttonholes, use the eyelet punch to make a hole in the rounded end of the buttonhole, and then use the seam ripper to cut open the buttonhole.

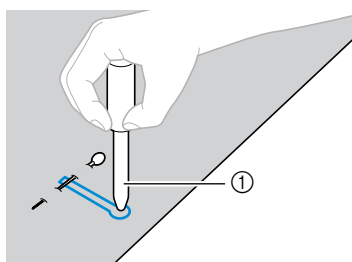

① Eyelet punch

- When using the eyelet punch, place thick paper or some other protective sheet under the fabric before punching the hole in the fabric.

## CAUTION

- When opening the buttonhole with the seam ripper, do not place your hands in the cutting direction, otherwise injuries may result if the seam ripper slips.

■ Changing the density of the stitching  
Adjust the stitch length.

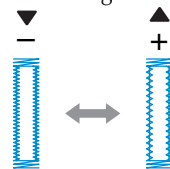

- For details, refer to “Adjusting the stitch length” (page 56).
- If the fabric does not feed (for example, if it is too thick), increase the density of the stitching.

■ Changing the stitch width  
Adjust the stitch width.

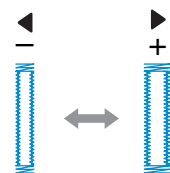

- For details, refer to “Adjusting the stitch width” (page 55).

## Memo

- Before sewing buttonholes, check the stitch length and width by sewing a trial buttonhole on a scrap piece of fabric.

■ Sewing buttonholes on stretch fabrics

When sewing buttonholes on stretch fabrics, use a gimp thread.

1 Hook the gimp thread onto the part of buttonhole foot “A” shown in the illustration so that it fits into the grooves, and then loosely tie it.

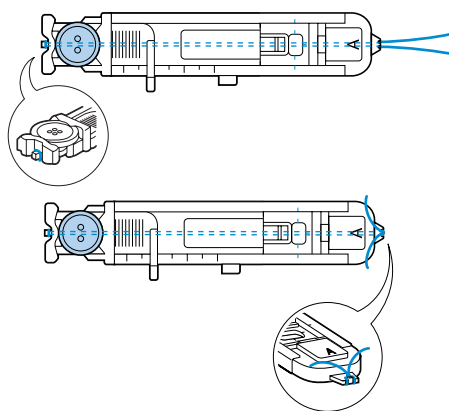

- 2 Attach buttonhole foot "A".
  - For details, refer to "Replacing the presser foot" (page 37).
- 3 Select stitch 46 or 47.
- 4 Adjust the stitch width to the thickness of the gimp thread.
- 5 Lower the presser foot lever and the buttonhole lever, and then start sewing.
- 6 When sewing is finished, gently pull the gimp thread to remove any slack.

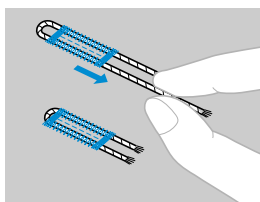

- 7 Use a handsewing needle to pull the gimp thread to the wrong side of the fabric, and then tie it.
- 8 With a seam ripper, cut the middle part of the gimp thread remaining at the top end of the buttonhole. Trim off any excess of the gimp thread.

## Button sewing

Buttons can be sewn on with the sewing machine. Buttons with 2 or with 4 holes can be attached.

- 1 Raise the presser foot lever, and then slide the drop feed lever, located at the rear of the machine on the base, to the right (to the right as seen from the front of the machine).

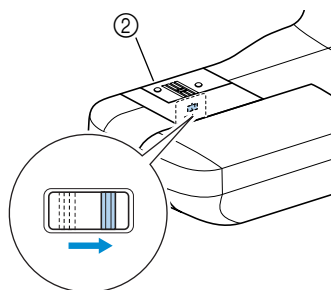
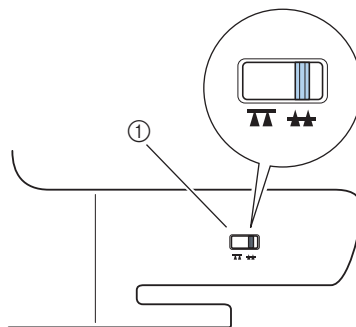

- ① Drop feed lever (as seen from the rear of the machine)
  - ② Back side
- The feed dogs are lowered.

- 2 Attach button-sewing foot "M".

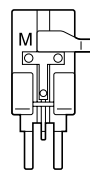

- For details, refer to "Replacing the presser foot" (page 37).



### 3 Place the button into button-sewing foot “M”.

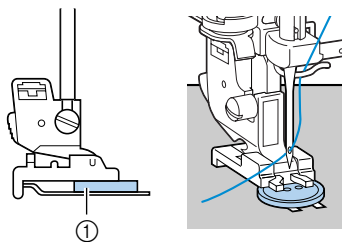

① Button

- When attaching four-hole buttons, first sew the two holes closest to you. Then, slide the button so that the needle goes into the two holes toward the rear of the sewing machine, and then sew them in the same way.

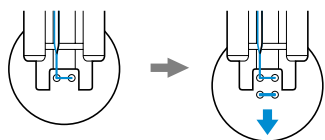

### 4 Select stitch 55.

- For details, refer to “Selecting stitching” (page 68).
- Leave automatic thread-cutting set to OFF.

### 5 Turn the balance wheel toward you to check that the needle correctly goes into the two holes of the button.

Adjust the stitch width to the distance between the button holes.

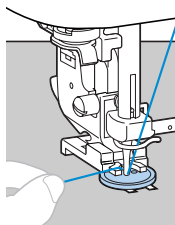
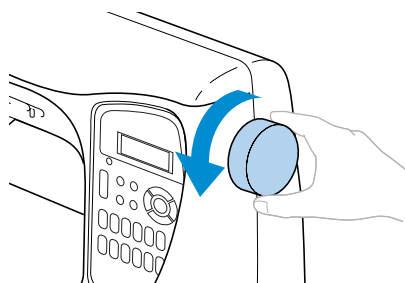

### CAUTION

- When sewing, be sure that the needle does not touch the button, otherwise the needle may bend or break.

### 6 Start sewing.

- ▶ The sewing machine automatically stops after sewing reinforcement stitches.
- If additional strength is needed to secure the button, perform the button-sewing operation twice.
- Do not press the thread cutter button.

### 7 Pull the upper thread at the end of the stitching to the wrong side of the fabric, and then tie it with the bobbin thread.

Use scissors to cut the upper thread and the bobbin thread at the beginning of the stitching.

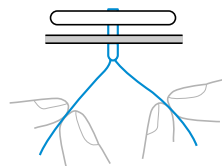

### 8 When you are finished attaching the button, slide the drop feed lever to ▲▲ (to the left as seen from the front of the machine) to raise the feed dogs.

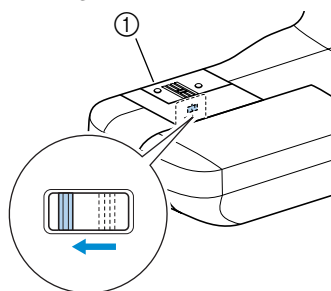

① Back side

### ■ Attaching a shank to a button

To sew the button with a shank, attach the button with space between it and the fabric, and then wind the thread by hand. This attaches the button securely.

- 1 Place the button into button-sewing foot “M”, and then pull the shank lever toward you.

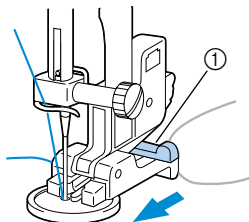

① Shank lever

- 2 After sewing is finished, cut the upper thread with plenty of excess, wind it around the thread between the button and the fabric, and then tie it to the upper thread at the beginning of the stitching.

Tie together the ends of the bobbin thread at the end and at the beginning of the stitching at the wrong side of the fabric.



- 3 Cut off any excess thread.

# Zipper Insertion

A zipper can be sewn in place.

Stitch Name	Pattern	Stitch Key	Application	Stitch Width [mm (inch.)]		Stitch Length [mm (inch.)]		Presser Foot
				Auto	Manual	Auto	Manual	
<b>Straight stitch (center needle position)</b>	3    - - -		Attaching zippers Sewing concealed seams and pintucks	-	-	2.5 (3/32)	0.2–5.0 (1/64–3/16)	

There are many methods for inserting zippers. The procedures for inserting a centered zipper and a side zipper are described below.

## Inserting a centered zipper

Stitching is sewn on both pieces of fabric butted against each other.

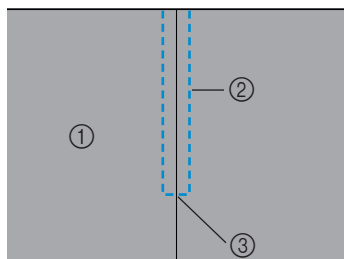

- ① Right side of fabric
- ② Stitching
- ③ End of zipper opening

### 1 Attach zigzag foot “J” and sew straight stitches up to the zipper opening.

With the right sides of the fabric facing each other, sew reverse stitches after reaching the zipper opening.

- For details, refer to “Basic Stitching” (page 74).

### 2 Using a basting stitch, continue sewing to the edge of the fabric.

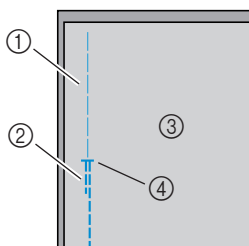

- ① Basting stitching
- ② Reverse stitches
- ③ Wrong side of fabric
- ④ End of zipper opening

### 3 Press open the seam allowance from the wrong side of the fabric.

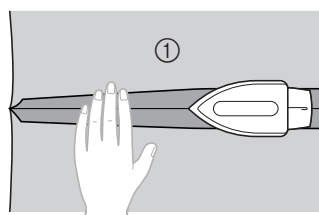

- ① Wrong side of fabric

### 4 Align the seam with the center of the zipper, and then baste the zipper in place.

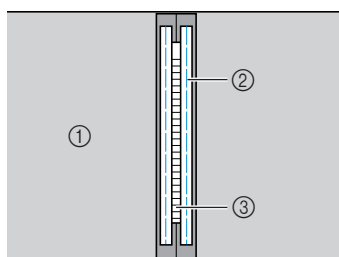

- ① Wrong side of fabric
- ② Basting stitching
- ③ Zipper

### 5 Attach the presser foot holder to the right pin of zipper foot “1”.

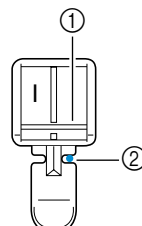

- ① Pin on the right side
- ② Needle drop point

- For details, refer to “Replacing the presser foot” (page 37).

**6** Select stitch <sup>3</sup> .

- For details, refer to “Selecting stitching” (page 68).

**CAUTION**

- When using zipper foot “I”, be sure to select the straight stitch (center needle position), and slowly turn the balance wheel toward you to check that the needle does not touch the presser foot. If a different stitch is selected or the needle hits the presser foot, the needle may bend or break.

**7** Topstitch around the zipper.

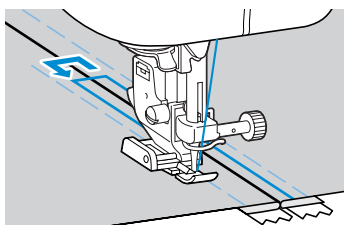
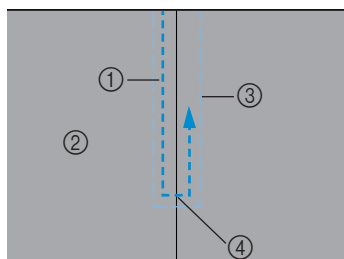

- ① Stitching
- ② Right side of fabric
- ③ Basting stitching
- ④ End of zipper opening

**CAUTION**

- When sewing, be sure that the needle does not touch the zipper, otherwise the needle may bend or break.

**8** Remove the basting stitching.

**Inserting a side zipper**

Stitching is sewn on only one piece of fabric. Use this type of zipper for side openings and back openings.

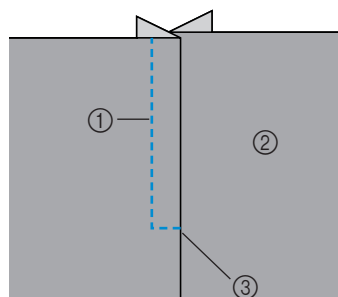

- ① Stitching
- ② Right side of fabric
- ③ End of zipper opening

The following procedure will describe how to stitch on the left side, as shown in the illustration.

**1** Attach zigzag foot “J” and sew straight stitches up to the zipper opening.

With the right sides of the fabric facing each other, sew reverse stitches after reaching the zipper opening.

- For details, refer to “Basic Stitching” (page 74).

**2** Using a basting stitch, continue sewing to the edge of the fabric.

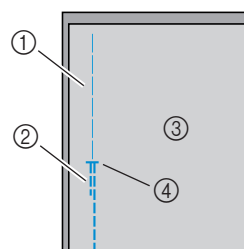

- ① Basting stitching
- ② Reverse stitches
- ③ Wrong side of fabric
- ④ End of zipper opening

**3** Press open the seam allowance from the wrong side of the fabric.

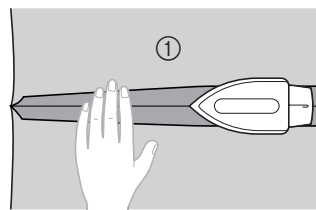

- ① Wrong side of fabric

- 4** Press the seam allowance so that the right side (the side that will not be stitched) has an extra 3 mm (1/8 inch).

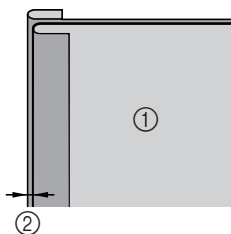

- ① Wrong side of fabric  
② 3 mm (1/8 inch)

- 5** Align the zipper teeth with the pressed edge of the fabric having the extra 3 mm (1/8 inch), and then baste or pin the zipper in place.

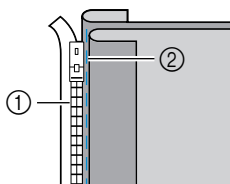

- ① Zipper teeth  
② Basting stitching

- 6** Attach the presser foot holder to the right pin of zipper foot "I".

If the stitching will be sewn on the right side, attach the presser foot holder to the left pin of the zipper foot.

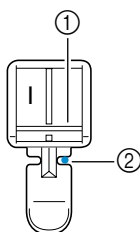

- ① Pin on the right side  
② Needle drop point

- For details, refer to "Replacing the presser foot" (page 37).

- 7** Select stitch <sup>3</sup> " " .

- For details, refer to "Selecting stitching" (page 68).

**CAUTION**

- When using zipper foot "I", be sure to select the straight stitch (center needle position), and slowly turn the balance wheel toward you to check that the needle does not touch the presser foot. If a different stitch is selected or the needle hits the presser foot, the needle may bend or break.

- 8** Sew the zipper to the piece of fabric with the extra 3 mm (1/8 inch), starting from the base of the zipper.

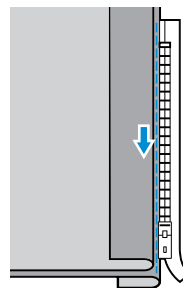

**CAUTION**

- When sewing, be sure that the needle does not touch the zipper, otherwise the needle may bend or break.

- 9** When you are about 5 cm (2 inch) from the end of the zipper, stop the sewing machine with the needle lowered (in the fabric), raise the presser foot lever, and then open the zipper and continue sewing.

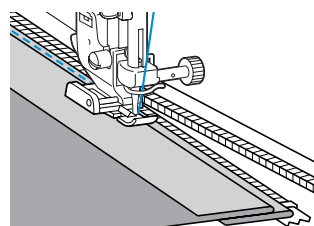

- 10** Close the zipper, turn over the fabric, and then baste the other side of the zipper to the fabric.

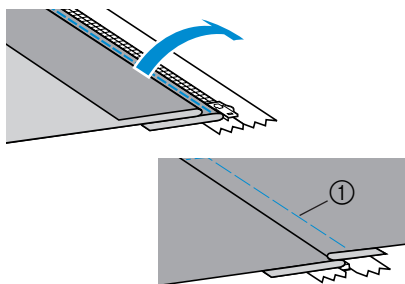

① Basting stitching

- 11** Attach the presser foot holder to the other pin of zipper foot “1”.

If the presser foot holder was attached to the right pin in step 6, change it to the left pin.

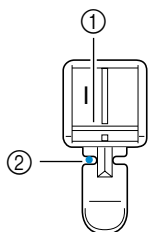

① Pin on the left side  
② Needle drop point

- 12** Topstitch around the zipper. Sew reverse stitches at the end of the zipper opening and align the zipper teeth with the side of the presser foot.

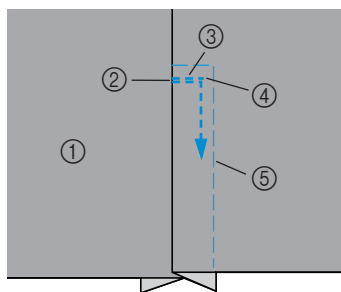

① Right side of fabric  
② End of zipper opening  
③ Reverse stitches  
④ Beginning of stitching  
⑤ Basting stitching

- 13** When you are about 5 cm (2 inch) from the end of the zipper, stop the sewing machine with the needle lowered (in the fabric), and then raise the presser foot lever.

- 14** Remove the basting stitching, open the zipper, and then continue sewing.

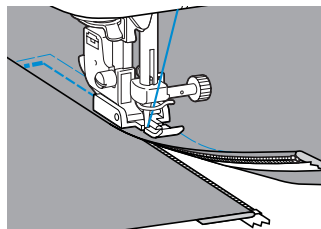

# Zipper/piping Insertion

A zipper and piping can be sewn in place.

Stitch Name	Pattern	Stitch Key	Application	Stitch Width [mm (inch.)]		Stitch Length [mm (inch.)]		Presser Foot
				Auto	Manual	Auto	Manual	
Straight stitch (left needle position)	1		Attaching zippers Sewing concealed seams and piping	0.0 (0)	0.0–7.0 (0–1/4)	2.5 (3/32)	0.2–5.0 (1/64–3/16)	

There are many methods for inserting zippers and pipings. The procedures for inserting a centered zipper and a piping are described below, with the adjustable zipper/piping foot.

## Inserting a centered zipper

- 1 Refer to step 1–4 of “Inserting a centered zipper” (page 85).
- 2 Remove the presser foot and presser foot holder (page 39) to attach the screw-on adjustable zipper/piping foot.

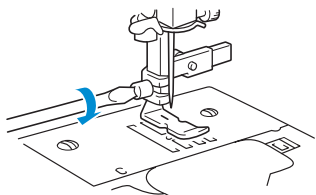

### Note

- Use a screw driver to securely tighten the screw that holds the presser foot. If the screw is loose, the needle may break and cause injuries.

- 3 Select stitch 1 ||.
- 4 Loosen the positioning screw on the back of the presser foot.

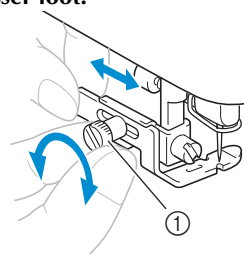

① Positioning screw

- 5 Slide the presser foot over either the left or right feed dog.

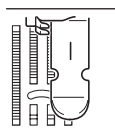
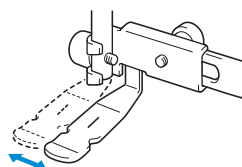

Left sewing position

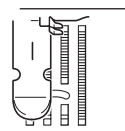

Right sewing position

- 6 Change the needle position so that the needle does not touch the presser foot. For details, refer to “Adjusting the stitch width” (page 55).



① Needle drop point

### CAUTION

- After adjusting the needle position, slowly turn the balance wheel toward you and check the needle does not touch the presser-foot. If the needle hits the presser foot, the needle may bend or break.

- 7** Securely tighten the positioning screw with a screwdriver.

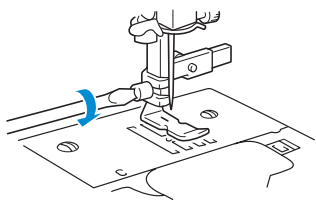

① Positioning screw

- 8** Topstitch around the zipper.

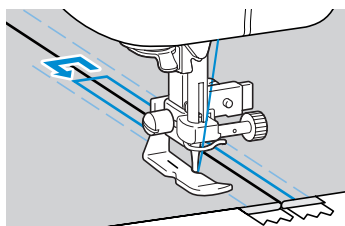
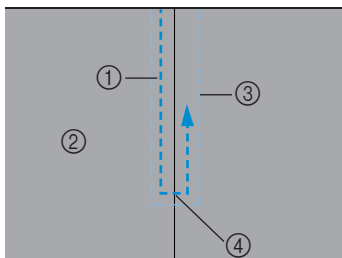

① Stitching  
② Right side of fabric  
③ Basting stitching  
④ End of zipper opening

**CAUTION**

- When sewing, be sure that the needle does not touch the zipper, otherwise the needle may bend or break.

- 9** Remove the basting stitching.

**Inserting a piping**

- 1** Place the piping between two fabrics inside out, as shown below.

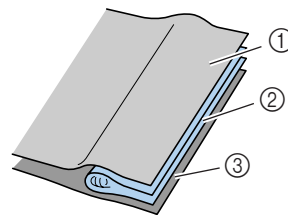

① Fabric  
② Piping  
③ Fabric

- 2** Refer to the steps of attaching the adjustable zipper/piping foot on the previous page.

- 3** Sew along the piping.

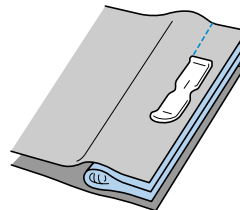

- 4** After sewing, turn them over.

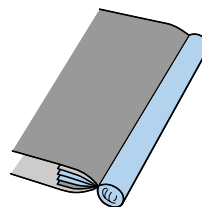



# Sewing Stretch Fabrics and Elastic Tape

Stretch fabrics can be sewn and elastic tape can be attached.

Stitch Name	Pattern	Stitch Key	Application	Stitch Width [mm (inch.)]		Stitch Length [mm (inch.)]		Presser Foot
				Auto	Manual	Auto	Manual	
Stretch stitch	5		Stretch fabrics	1.0 (1/16)	1.0–3.0 (1/16–1/8)	2.5 (3/32)	1.0–4.0 (1/16–3/16)	J
2-point zigzag stitch	9	–	Attaching elastic	5.0 (3/16)	1.5–7.0 (1/16–1/4)	1.0 (1/16)	0.2–4.0 (1/64–3/16)	
3-point zigzag stitch	10			5.0 (3/16)	1.5–7.0 (1/16–1/4)	1.0 (1/16)	0.2–4.0 (1/64–3/16)	
Elastic-attaching stitch	28	–	Attaching elastic to stretch fabrics	4.0 (3/16)	0.0–7.0 (0–1/4)	1.0 (1/16)	0.2–4.0 (1/64–3/16)	

Observe the corresponding precautions when performing each of the following stitching operations.

## Stretch stitching

### 1 Attach zigzag foot “J”.

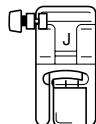

- For details, refer to “Replacing the presser foot” (page 37).

### 2 Select stitch 5

- For details, refer to “Selecting stitching” (page 68).

### 3 Sew the fabric without stretching it.

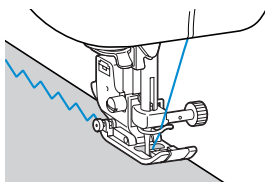

## Elastic attaching

When elastic tape is attached to the cuff or waist of a piece of clothing, the finished dimensions will be that of the stretched elastic tape. Therefore, it is necessary that a suitable length of the elastic tape be used.

### 1 Pin the elastic tape to the wrong side of the fabric.

Pin the elastic tape to the fabric at a few points to make sure that the tape is uniformly positioned on the fabric.

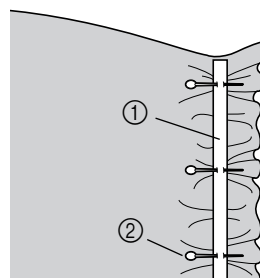

- ① Elastic tape
- ② Pin

### 2 Attach zigzag foot “J”.

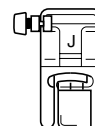

- For details, refer to “Replacing the presser foot” (page 37).

- 3** **Select a stitch.**
- For details, refer to “Selecting stitching” (page 68).

- 4** **Sew the elastic tape to the fabric while stretching the tape so that it is the same length as the fabric.**

While pulling the fabric behind the presser foot with your left hand, pull the fabric at the pin nearest the front of the presser foot with your right hand.

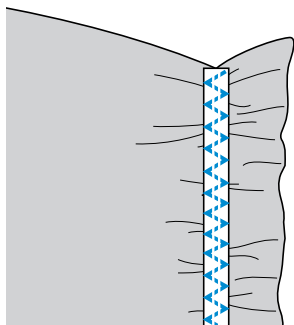
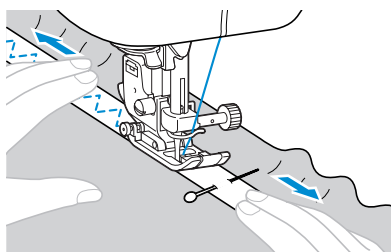













**! CAUTION**

- **When sewing, be sure that the needle does not touch any pins, otherwise the needle may bend or break.**

# Appliqué, Patchwork and Quilt Stitching

The stitches that can be used for sewing appliqués, patchwork and quilts are described below.

Stitch Name	Pattern	Stitch Key	Application	Stitch Width [mm (inch.)]		Stitch Length [mm (inch.)]		Presser Foot
				Auto	Manual	Auto	Manual	
Zigzag stitch	7 		Attaching appliqués (center baseline/reverse stitching)	3.5 (1/8)	0.0–7.0 (0–1/4)	1.4 (1/16)	0.0–4.0 (0–3/16)	J
	60 	–	Appliqué quilting, free-motion quilting, satin stitching	3.5 (1/8)	0.0–7.0 (0–1/4)	1.4 (1/16)	0.0–4.0 (0–3/16)	
Appliqué stitch	19 		Attaching appliqués	3.5 (1/8)	2.5–5.0 (3/32–3/16)	2.5 (3/32)	1.6–4.0 (1/16–3/16)	
	61 	–	Attaching appliqués and binding	1.5 (1/16)	0.5–5.0 (1/32–3/16)	1.2 (1/16)	1.0–4.0 (1/16–3/16)	
Piecing straight stitch	57 	–	Piecing straight stitching (with a seam allowance of 6.5 mm from the right edge of the presser foot)	5.5 (7/32)	0.0–7.0 (0–1/4)	1.6 (1/16)	0.2–5.0 (1/64–3/16)	
	58 	–	Piecing straight stitching (with a seam allowance of 6.5 mm from the left edge of the presser foot)	1.5 (1/16)	0.0–7.0 (0–1/4)	1.6 (1/16)	0.2–5.0 (1/64–3/16)	
Joining stitch	22 	–	Patchwork stitching	4.0 (3/16)	0.0–7.0 (0–1/4)	1.2 (1/16)	0.2–4.0 (1/64–3/16)	
	23 	–		5.0 (3/16)	2.5–7.0 (3/32–1/4)	2.5 (3/32)	1.0–4.0 (1/16–3/16)	
	24 	–		5.0 (3/16)	0.0–7.0 (0–1/4)	1.2 (1/16)	0.2–4.0 (1/64–3/16)	
Mock hand quilting stitch	59 	–	Straight stitch quilting that looks hand quilting	0.0 (0)	0.0–7.0 (0–1/4)	2.5 (3/32)	1.0–4.0 (1/16–3/16)	
Quilting stippling	62 	–	Stippling	7.0 (1/4)	1.0–7.0 (1/16–1/4)	1.6 (1/16)	1.0–4.0 (1/16–3/16)	

## Appliqué stitching

- 1 Cut out the appliqué, leaving a seam allowance of between 3 and 5 mm (1/8 and 3/16 inch).

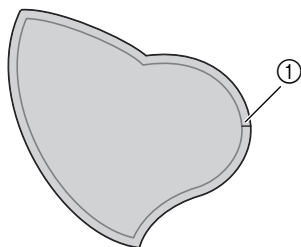

① Seam allowance

- 2 Place a pattern made of thick paper on the back of the appliqué, and then fold over the seam allowance using an iron.

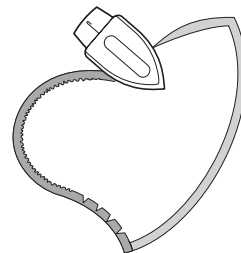

- Remove the thick paper after pressing the seam allowance.

- 3** Turn the fabric over, and then baste or pin it onto the fabric that it will be attached to.

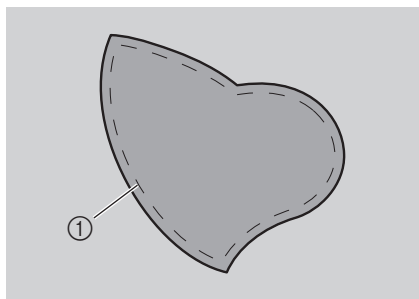

① Basting stitching

- 4** Attach the open toe foot.

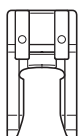

- For details, refer to “Replacing the presser foot” (page 37).

- 5** Select a stitch.

- For details, refer to “Selecting stitching” (page 68).

- 6** Turn the balance wheel toward you, and then begin sewing around the edge of the appliqué, making sure that the needle drops just outside of the appliqué.

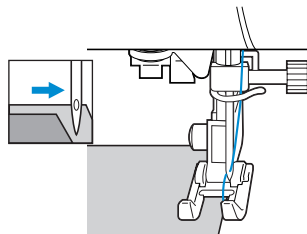

When sewing around corners, stop the machine with the needle in the fabric just outside of the appliqué, raise the presser foot lever, and then turn the fabric as needed to change the sewing direction.

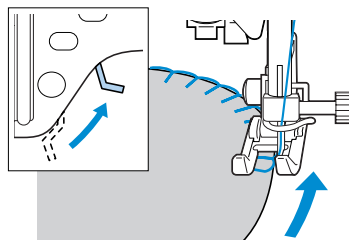

## Patchwork (crazy quilt) stitching

- 1 Fold the edge of the top piece of fabric and place it over the lower piece.
- 2 Sew the two pieces of fabric together so the pattern spans over both pieces.

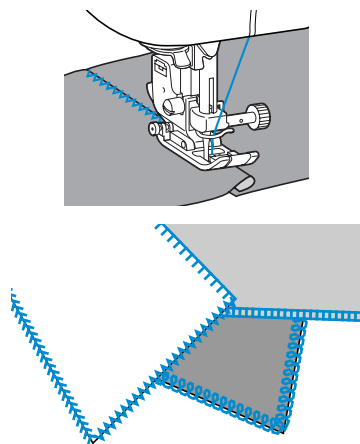

## Piecing

Sewing together two pieces of fabric is called "piecing". The fabric pieces should be cut with a 6.5 mm (1/4 inch) seam allowance. Sew a piecing straight stitch 6.5 mm (1/4 inch) from either the right side or the left side of the presser foot.

- 1 Baste or pin along the seam allowance of the fabric that you wish to piece together.

- 2 Attach zigzag foot "J".

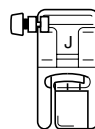

- For details, refer to "Replacing the presser foot" (page 37).

- 3 Select stitch <sup>57</sup> | | or <sup>58</sup> | | .  
P P

- For details, refer to "Selecting stitching" (page 68).

- 4 Sew with the side of the presser foot aligned with the edge of the fabric.

### ■ For a seam allowance on the right side

Align the right side of the presser foot with the edge of the fabric, and sew using stitch <sup>57</sup> | | .  
P

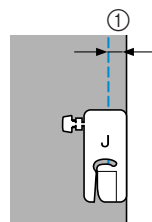

① 6.5 mm (1/4 inch)

### ■ For a seam allowance on the left side

Align the left side of the presser foot with the edge of the fabric, and sew using stitch <sup>58</sup> | | .  
P

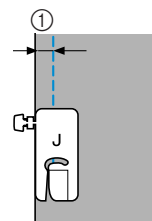

① 6.5 mm (1/4 inch)

**Memo**

- To change the width of the seam allowance (the needle position), adjust the stitch width.

**Quilting**

Sandwiching batting between the top and bottom layers of fabric is called “quilting”. Quilts can easily be sewn using the walking foot and the quilting guide.

- 1 Baste the fabric to be quilted.**
- 2 Attach the walking foot.**
  - For details, refer to “Using the walking foot” (page 40).
- 3 Select a stitch.**
  - For details, refer to “Selecting stitching” (page 68).
- 4 Place one hand on each side of the presser foot, and then evenly stretch the fabric while sewing.**

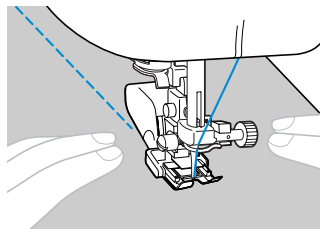
**Note**

- When sewing with the walking foot, sew at a speed between slow and medium.

## ■ Using the optional quilting guide

Use the quilting guide to sew parallel stitches that are equally spaced.

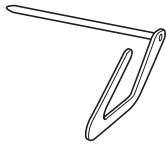

- 1 Insert the stem of the quilter into the hole at the rear of the walking foot or presser foot holder.

Walking foot

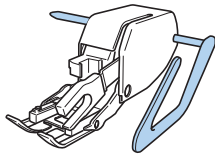

Presser foot holder

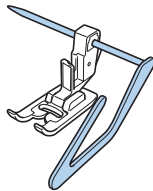

- 2 Adjust the stem of the quilter so that the quilt guide aligns with the seam that has already been sewn.

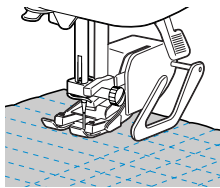

### Note

- The optional quilting guide is available through your brother retailer.

## Free-motion quilting

With free-motion quilting, the feed dogs can be lowered (using the drop feed lever) so that the fabric can be moved freely in any direction. The quilting foot is needed for free-motion quilting.

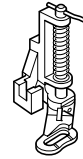

- 1 Remove the presser foot and the presser foot holder.

- Refer to "Removing the presser foot holder" (page 39).

- 2 Align the quilting foot with the lower-left side of the presser bar.

The pin on the quilting foot should be positioned over the needle clamp screw.

- 3 Hold the quilting foot in place with your right hand, and then tighten the presser foot holder screw using the screwdriver in your left hand.

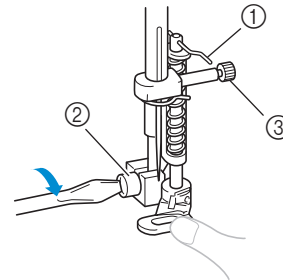

- ① Pin on quilting foot
- ② Presser foot holder screw
- ③ Needle clamp screw

### ! CAUTION

- Be sure to securely tighten the screws with the screwdriver, otherwise the needle may touch the presser foot, causing it to bend or break.

- 4** Slide the drop feed lever, located at the rear of the machine on the base, to  (to the right as seen from the front of the machine).

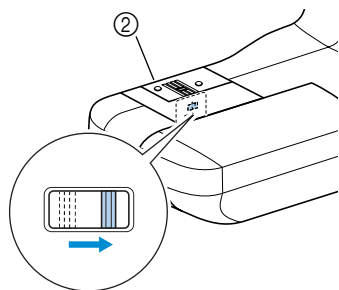
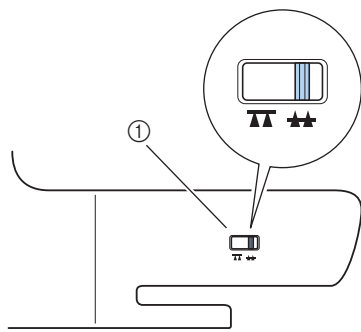

- ① Feed dog position switch  
(as seen from the rear of the machine)
- ② Back side
- The feed dogs are lowered.

- 5** Turn on the sewing machine, and then select a stitch.

- For details, refer to “Selecting stitching” (page 68).

- 6** Use both hands to stretch the fabric taut, and then move the fabric to follow the pattern. Reinforcement stitches are sewn at the beginning and end of sewing.

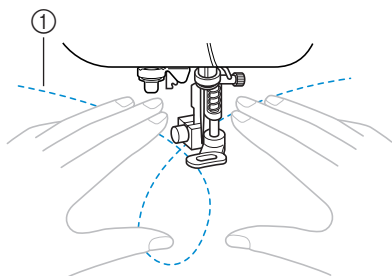

- ① Pattern

- 7** After sewing is finished, slide the drop feed lever to  (to the left as seen from the front of the machine) to raise the feed dogs.

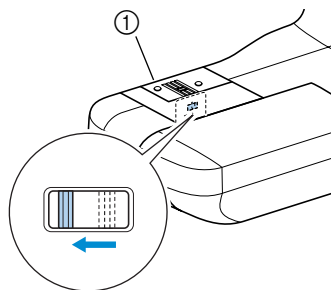

- ① Back side
- Normally, the drop feed lever is positioned at the left.



## Satin stitching

A decorative stitch can be sewn by changing the stitch width of a satin stitch. If the sewing machine is set so that the stitch width can be adjusted using the sewing speed controller, the stitch width can quickly and easily be adjusted. In this case, the sewing speed is adjusted with the foot controller.

- 1 Connect the foot controller.**
  - For details, refer to “Starting to sew” (page 49).



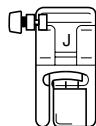

- 2 Attach zigzag foot “J”.**



- For details, refer to “Replacing the presser foot” (page 37).

- 3 Turn on the sewing machine, and then press  (settings key) in the operation panel.**

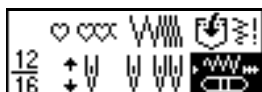

▶ The settings screen appears.

- 4 Press , ,  and  (arrow keys) until  is selected.**



- 5 Press  (OK key).**

▶ The screen for specifying that the stitch width can be controlled with the sewing speed controller appears.

- 6 Press  to select **ON**.**  
To return to **OFF**, press .



▶ The machine is now set so that the stitch width can be controlled with the sewing speed controller.

- 7 Press  (OK key).**

▶ The initial stitch screen appears again.

- 8 Select stitch .**

- For details, refer to “Selecting stitching” (page 68).

- 9 While sewing, slide the sewing speed controller to adjust the stitch width.**

Slide the controller to the left to make the width narrower. Slide the controller to the right to make the width wider.

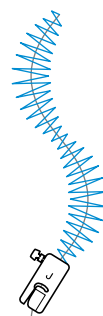
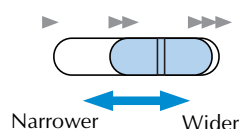

- Adjust the sewing speed with the foot controller.

- 10 When you are finished sewing, set the stitch width control setting back to **OFF**.**



### Memo

- Although the stitching result differs depending on the type of fabric being sewn and the thickness of the thread being used, for best results, adjust the stitch length to between 0.3 and 0.5 mm (1/64 and 1/32 inch).

# Reinforcement Stitching

Reinforce points that will be subject to strain, such as sleeve holes, inseams and pocket corners.

Stitch Name	Pattern	Stitch Key	Application	Stitch Width [mm (inch.)]		Stitch Length [mm (inch.)]		Presser Foot
				Auto	Manual	Auto	Manual	
Triple stretch stitch	4		Reinforcing the seams of sleeves and inseams	0.0 (0)	0.0–7.0 (0–1/4)	2.5 (3/32)	1.5–4.0 (1/16–3/16)	J
Bar tack stitch	54	–	Reinforcing the ends of openings, such as the corners of pockets	2.0 (1/16)	1.0–3.0 (1/16–1/8)	0.4 (1/64)	0.3–1.0 (1/64–1/16)	A
Darning stitch	52	–	Darning mediumweight fabrics	7.0 (1/4)	2.5–7.0 (3/32–1/4)	2.0 (1/16)	0.4–2.5 (1/64–3/32)	
	53	–	Darning thick fabrics	7.0 (1/4)	2.5–7.0 (3/32–1/4)	2.0 (1/16)	0.4–2.5 (1/64–3/32)	

## Triple stretch stitching

Use triple stretch stitching to reinforce sleeve holes and inseams.

### 1 Attach zigzag foot “J”.

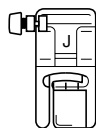

- For details, refer to “Replacing the presser foot” (page 37).

### 2 Select stitch 4

- For details, refer to “Selecting stitching” (page 68).

### 3 Start sewing.

- For details, refer to “Starting to sew” (page 49).

## Bar tack stitching

Bar tacks are used to reinforce points subject to strain, such as pocket corners and openings. As an example, the procedure for sewing bar tacks at pocket corners is described below.

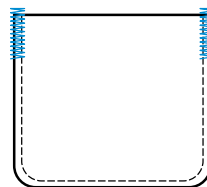

### 1 Determine the desired length of the bar tack. Set the button guide plate on buttonhole foot “A” to the desired length. (The distance between the markings on the presser foot scale is 5 mm (3/16 inch).)

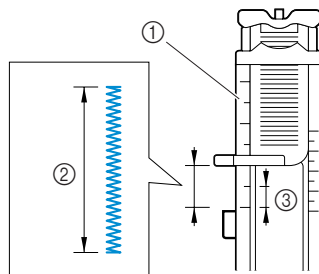

- ① Presser foot scale
- ② Length of bar tack
- ③ 5 mm (3/16 inch)

- A bar tack with a maximum length of about 28 mm (1–1/8 inch) can be sewn.

- 2 Attach buttonhole foot “A”.**
- For details, refer to “Replacing the presser foot” (page 37).

- 3 Select stitch 54** .
- For details, refer to “Selecting stitching” (page 68).

- 4 Position the fabric so that the opening of the pocket faces toward you, and then lower the presser foot lever so that the needle drops 2 mm (1/16 inch) in front of the pocket opening.**

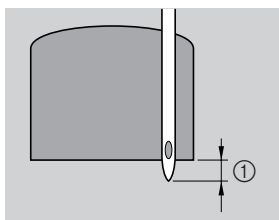

① 2 mm (1/16 inch)

Pass the upper thread down through the hole in the presser foot.

- When lowering the presser foot, do not push in the front of the presser foot, otherwise the bar tack will not be sewn with the correct size.

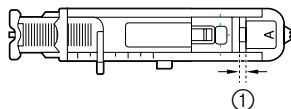
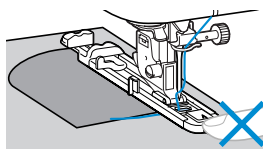

① Do not reduce the gap.

- 5 Pull down the buttonhole lever as far as possible.**

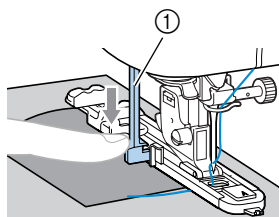

① Buttonhole lever

The buttonhole lever is positioned behind the bracket on the buttonhole foot.

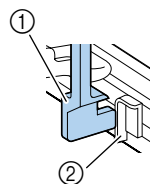

① Buttonhole lever  
② Bracket

- 6 Gently hold the end of the upper thread in your left hand, and then start sewing.**

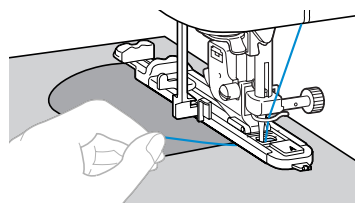

- ▶ Once sewing is completed, the machine automatically sews reinforcement stitches, then stops

- 7 Cut the threads, raise the presser foot lever, and then remove the fabric.**

- 8 Raise the buttonhole lever to its original position.**

### Memo

- If the fabric does not feed, for example, because it is too thick, increase the stitch length. For details, refer to “Adjusting the stitch length” (page 56).

## Darning

Fabric that has been torn can be darned.  
Darning is sewn as shown below.

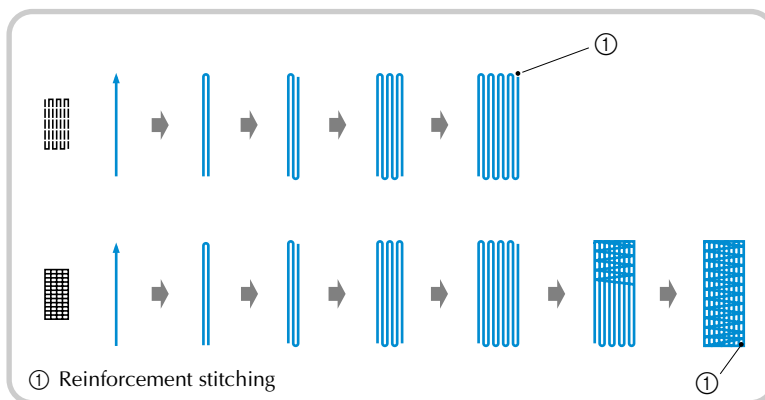

- Determine the desired length of the darning.** Set the button guide plate on buttonhole foot "A" to the desired length. (The distance between the markings on the presser foot scale is 5 mm (3/16 inch).)

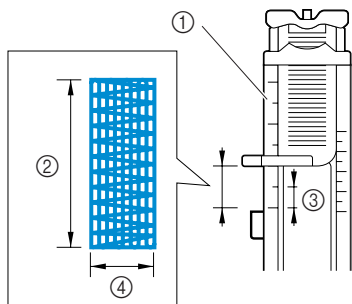

- ① Presser foot scale
- ② Length of darning
- ③ 5 mm (3/16 inch)
- ④ 7 mm (1/4 inch)

- A bar tack with a maximum length of about 28 mm (1-1/8 inch) can be sewn.

- Attach buttonhole foot "A".**
  - For details, refer to "Replacing the presser foot" (page 37).

- Select stitch 52 or 53.**
  - For details, refer to "Selecting stitching" (page 68).

- Position the fabric so that the needle is 2 mm (1/16 inch) in front of the area to be darned, and then lower the presser foot lever.**

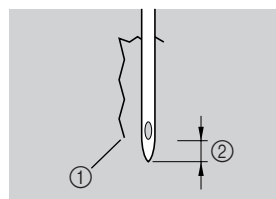

- ① Tear
- ② 2 mm (1/16 inch)

Pass the upper thread down through the hole in the presser foot.

- When lowering the presser foot, do not push in the front of the presser foot, otherwise the darning will not be sewn with the correct size.

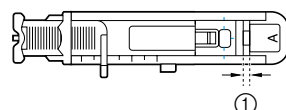
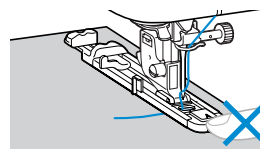

- ① Do not reduce the gap.

- 5 Pull down the buttonhole lever as far as possible.**

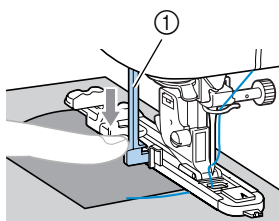

① Buttonhole lever

The buttonhole lever is positioned behind the bracket on the buttonhole foot.

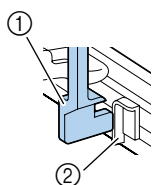

① Buttonhole lever  
② Bracket

- 6 Gently hold the end of the upper thread in your left hand, and then start sewing.**

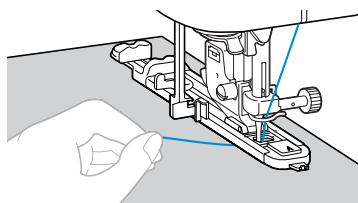

► Once sewing is completed, the machine automatically sews reinforcement stitches, then stops

- 7 Cut the threads, raise the presser foot lever, and then remove the fabric.**

- 8 Raise the buttonhole lever to its original position.**



### Memo

- If the fabric does not feed, for example, because it is too thick, increase the stitch length. For details, refer to "Adjusting the stitch length" (page 56).

## Eyelet Stitching

Eyelets, such as those on belts, can be sewn. Three sizes of eyelets are possible: 7 mm, 6 mm and 5 mm (1/4, 15/64 and 3/16 inch).

Stitch Name	Pattern	Application	Stitch Width [mm (inch.)]		Stitch Length [mm (inch.)]		Presser Foot
			Auto	Manual	Auto	Manual	
Eyelet stitch	<sup>56</sup> 	Sewing eyelets, for example, on belts	7.0 (1/4)	7.0, 6.0 or 5.0 (1/4, 15/64 or 3/16)	7.0 (1/4)	7.0, 6.0 or 5.0 (1/4, 15/64 or 3/16)	N

### 1 Attach monogramming foot "N".

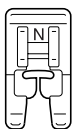

- For details, refer to "Replacing the presser foot" (page 37).

### 2 Select stitch <sup>56</sup> .

- For details, refer to "Selecting stitching" (page 68).

### 3 Adjust either the stitch width or the stitch length to select the desired eyelet size.



7 mm  
(1/4 inch)



6 mm  
(15/64 inch)



5 mm  
(3/16 inch)

- For details, refer to "Adjusting the Stitch Width and Length" (page 55).

### 4 Lower the needle into the fabric at the beginning of the stitching, and then lower the presser foot lever.

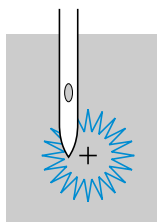

### 5 Start sewing.

- ▶ Once sewing is completed, the machine automatically sews reinforcement stitches, then stops

### 6 Use the eyelet punch to cut a hole in the center of the eyelet.

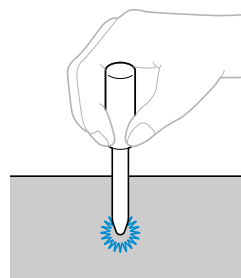

- When using the eyelet punch, place thick paper or some other protective sheet under the fabric before punching the hole in the fabric.

























#### Memo

- If thin thread is used, the stitching may be coarse. If this occurs, sew the eyelet twice, one on top of the other.

# Decorative Stitching

Various decorative stitches can be sewn with this sewing machine.

Stitch Name	Pattern	Application	Stitch Width [mm (inch.)]		Stitch Length [mm (inch.)]		Presser Foot	
			Auto	Manual	Auto	Manual		
Fagoting stitch	26 	Sewing two pieces of fabric together across an open seam	5.0 (3/16)	0.0–7.0 (0–1/4)	2.5 (3/32)	1.0–4.0 (1/16–3/16)	J	
	27 		5.0 (3/16)	2.5–7.0 (3/25–1/4)	2.5 (3/32)	1.0–4.0 (1/16–3/16)		
Joining stitch	22 	Decorative bridging stitches	4.0 (3/16)	0.0–7.0 (0–1/4)	1.2 (1/16)	0.2–4.0 (1/64–3/16)		
	23 		5.0 (3/16)	2.5–7.0 (3/32–1/4)	2.5 (3/32)	1.0–4.0 (1/16–3/16)		
	24 		5.0 (3/16)	0.0–7.0 (0–1/4)	1.2 (1/16)	0.2–4.0 (1/64–3/16)		
Shell tuck stitch	20 	Shell tuck stitching on collars and curves	4.0 (3/16)	0.0–7.0 (0–1/4)	2.5 (3/32)	0.2–4.0 (1/64–3/16)		
Smocking stitch	25 	Smocking fabrics to add texture and elasticity	5.0 (3/16)	0.0–7.0 (0–1/4)	1.6 (1/16)	1.0–4.0 (1/16–3/16)		
	26 		5.0 (3/16)	0.0–7.0 (0–1/4)	2.5 (3/32)	1.0–4.0 (1/16–3/16)		
	27 		5.0 (3/16)	2.5–7.0 (3/32–1/4)	2.5 (3/32)	1.0–4.0 (1/16–3/16)		
Scalloped stitch	21 	Satin scallop stitching	5.0 (3/16)	2.5–7.0 (3/32–1/4)	0.5 (1/32)	0.1–1.0 (1/64–1/16)		
Decorative stitch	33 	Lace sewing, decorative hemming, heirloom stitching, etc.	3.5 (1/8)	1.5–7.0 (1/16–1/4)	2.5 (3/32)	1.6–4.0 (1/16–3/16)		N
	34 		6.0 (15/64)	1.5–7.0 (1/16–1/4)	3.0 (1/8)	1.5–4.0 (1/16–3/16)		
	35 	Decorative hemming and heirloom stitching, etc. on thin, mediumweight and plain weave fabrics	5.0 (3/16)	1.5–7.0 (1/16–1/4)	3.5 (1/8)	1.5–4.0 (1/16–3/16)		
	36 		5.0 (3/16)	1.5–7.0 (1/16–1/4)	4.0 (3/16)	1.5–4.0 (1/16–3/16)		
	37 		5.0 (3/16)	1.5–7.0 (1/16–1/4)	2.5 (3/32)	1.5–4.0 (1/16–3/16)		
	38 		5.0 (3/16)	1.5–7.0 (1/16–1/4)	2.0 (1/16)	1.5–4.0 (1/16–3/16)		
	39 		Decorative hemming, ribbon threading, heirloom stitching, etc.	5.0 (3/16)	1.5–7.0 (1/16–1/4)	3.0 (1/8)	1.5–4.0 (1/16–3/16)	
	40 	Heirloom stitching, etc.	6.0 (15/64)	1.5–7.0 (1/16–1/4)	1.6 (1/16)	1.0–4.0 (1/16–3/16)		
41 	5.0 (3/16)		1.5–7.0 (1/16–1/4)	1.6 (1/16)	1.0–4.0 (1/16–3/16)			

Stitch Name	Pattern	Application	Stitch Width [mm (inch.)]		Stitch Length [mm (inch.)]		Presser Foot
			Auto	Manual	Auto	Manual	
Decorative stitch	29 	Decorative stitching	4.0 (3/16)	0.0–7.0 (0–1/4)	3.0 (1/8)	2.0–4.0 (1/16–3/16)	J
	30 		4.0 (3/16)	0.0–7.0 (0–1/4)	2.5 (3/32)	1.0–4.0 (1/16–3/16)	
	31 		5.5 (7/32)	0.0–7.0 (0–1/4)	1.6 (1/16)	1.0–4.0 (1/16–3/16)	
	32 		5.0 (3/16)	1.5–7.0 (1/16–1/4)	1.0 (1/16)	0.2–4.0 (1/64–3/16)	N

## Fagoting

Stitching across an open seam is called “fagoting”. It is used on blouses and children's clothing. This stitch is more decorative when thicker thread is used.

- Use an iron to fold the two pieces of fabric along their seams.
- Baste the two pieces of fabric, separated by about 4 mm (3/16 inch), onto thin paper or a sheet of water-soluble stabilizer.

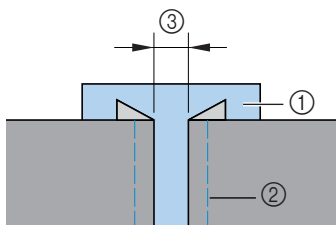

- Thin paper or water soluble stabilizer
- Basting stitching
- 4 mm (3/16 inch)

- Attach zigzag foot “J”.

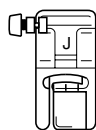

- For details, refer to “Replacing the presser foot” (page 37).

- Select stitch 26  or 27 .

- For details, refer to “Selecting stitching” (page 68).

- Set the stitch width to 7.0 mm (1/4 inch).

- For details, refer to “Adjusting the stitch width” (page 55).

- Sew with the center of the presser foot aligned along the center of the two pieces of fabric.

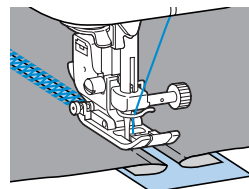
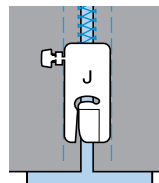

- After sewing is finished, remove the paper.



## Scallop stitching

The wave-shaped repeating pattern that looks like shells is called “scalloping”. It is used on the collars of blouses and to decorate the edges of handkerchiefs.

### 1 Attach monogramming foot “N”.

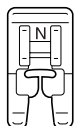

- For details, refer to “Replacing the presser foot” (page 37).

### 2 Select stitch <sup>21</sup> }.

- For details, refer to “Selecting stitching” (page 68).

### 3 Stitch along the edge of the fabric, making sure not to sew directly on the edge of the fabric.

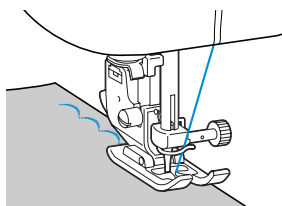

- For better results, apply spray starch onto the fabric and press with a hot iron before it is sewn.

### 4 Trim along the stitches.

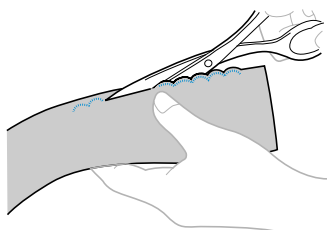

- Be careful not to cut the stitches.

## Smocking

The decorative stitch created by stitching or embroidering over gathers is called “smocking”. It is used to decorate the front of blouses or cuffs. The smocking stitch adds texture and elasticity to fabric.

### 1 Attach zigzag foot “J”.

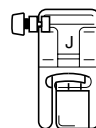

- For details, refer to “Replacing the presser foot” (page 37).

### 2 Select the straight stitch, and then adjust the stitch length to 4.0 mm (3/16 inch) and loosen the thread tension.

- For details, refer to “Adjusting the stitch length” (page 56) and “Changing the tension of the upper thread” (page 54).

### 3 Sew parallel stitching at intervals of 1 cm (3/8 inch).

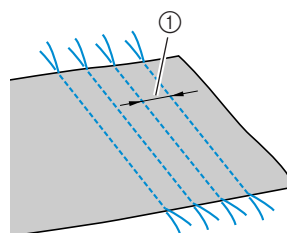



① 1 cm (3/8 inch)

- It is not necessary to sew reverse/reinforcement stitches or cut the thread.

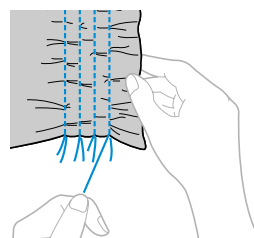
### 4 Pull the bobbin threads to create gathers. Smooth the gathers by ironing them.



- 5** Select stitch ,  or .
- For details, refer to “Selecting stitching” (page 68).

- 6** Stitch between the straight stitches.

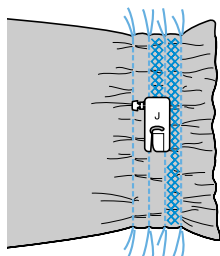

- 7** Pull out the threads for the straight stitches.

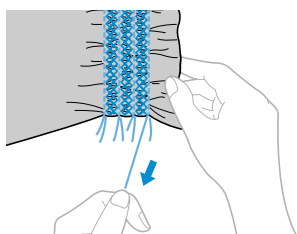

## Shell tuck stitching

The gathers that look like shells are called “shell tucks”. They are used to decorate trims, the front of blouses or cuffs made of thin fabrics.

- 1** Fold the fabric along the bias.

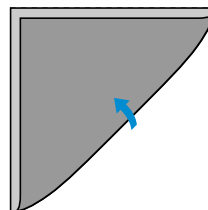

- 2** Attach zigzag foot “J”.

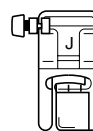

- For details, refer to “Replacing the presser foot” (page 37).

- 3** Select stitch , and then increase the thread tension.

- For details, refer to “Selecting stitching” (page 68).

- 4** Sew while making sure that the needle drops slightly off the edge of the fabric.

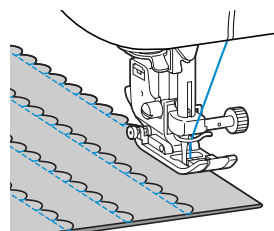
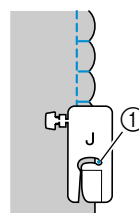

- ① Needle drop point

- 5** Unfold the fabric, and then iron the tucks down to one side.

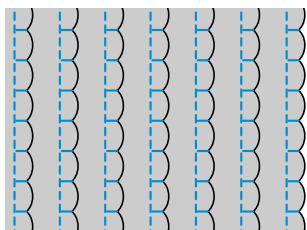

## Joining

Decorative bridging stitches can be sewn over the seam allowance of joined fabrics. This is used when making a crazy quilt.

- 1** Attach zigzag foot “J”.

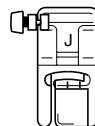

- For details, refer to “Replacing the presser foot” (page 37).

- 2** Sew together the right sides of the two pieces of fabric, and then open up the seam allowances.

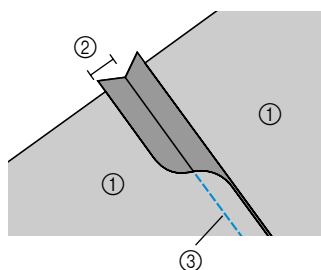

- ① Wrong side of fabric
- ② 6.5 mm (1/4 inch) seam allowance
- ③ Straight stitch

- 3** Select stitch 22, 23 or 24.

- For details, refer to “Selecting stitching” (page 68).

- 4** Turn the fabric over so that the right side faces up, and then sew over the seam with the center of the presser foot aligned with the seam.

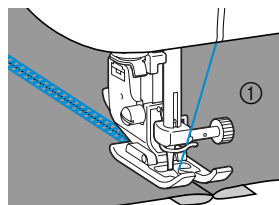

- ① Right side of fabric

## Heirloom stitching

When sewing with the wing needle, the needle holes are enlarged, creating a lace-like decorative stitch. This is used to decorate hems and tablecloths on thin or mediumweight fabrics in addition to plain weave fabrics.

### 1 Install the wing needle.

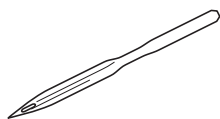

- Use a 130/705H 100/16 wing needle.
- For details on installing a needle, refer to “Replacing the needle” (page 35).
- The needle threader cannot be used with the wing needle, otherwise the sewing machine may be damaged. Manually pass the thread through the eye of the needle from the front.



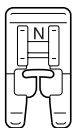



### 2 Attach monogramming foot “N”.





- For details, refer to “Replacing the presser foot” (page 37).

### 3 Select a stitch.

The stitches that can be used are <sup>33</sup> ,

34 , 35 , 36 , 37 , 38 , 39 ,

40  or 41 .

- For details, refer to “Selecting stitching” (page 68).
- Select a stitch width of 6.0 mm (15/64 inch) or less.

### 4 Start sewing.

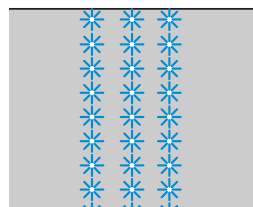

### ! CAUTION

- Select a stitch width of 6.0 mm (15/64 inch) or less, otherwise the needle may bend or break.
- After adjusting the stitch width, slowly turn the balance wheel toward you and check that the needle does not touch the presser foot. If the needle hits the presser foot, the needle may bend or break.

Partially removing threads is called “drawnwork”. This gives a beautiful result with fabrics that have a loose weave. Two ways to create drawnwork are described below.

### ■ Drawnwork (Example 1)

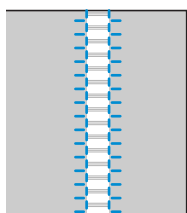

- 1 Pull out several threads from the fabric.

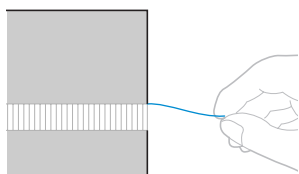

- 2 Attach monogramming foot “N”.

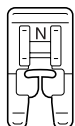

- For details, refer to “Replacing the presser foot” (page 37).

- 3 Select stitch 33.

- For details, refer to “Selecting stitching” (page 68).

- 4 With the right side of the fabric facing up, sew along the right edge of the frayed section.

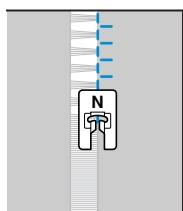

- 5 Press (settings key) in the operation panel.
  - ▶ The settings screen appears.

- 6 Press , , and (arrow keys) until is selected.



- 7 Press (OK key).

- ▶ The screen for mirror imaging the pattern appears.

- 8 Press to select . To return to , press .

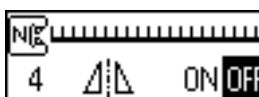

- ▶ The pattern is flipped.

- 9 Press (OK key).

- ▶ The initial stitch screen appears again.

- 10 Sew along the other edge of the frayed section so that it looks like the previous stitching.

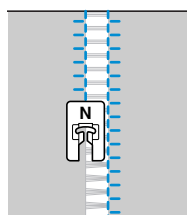

- 11 Set the mirror image pattern setting back to .

■ Drawnwork (Example 2)

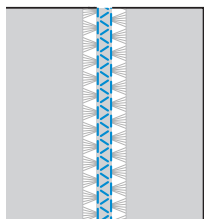

- 1 Pull out several threads from two sections of the fabric, separated by an unfrayed section of about 4 mm (3/16 inch).

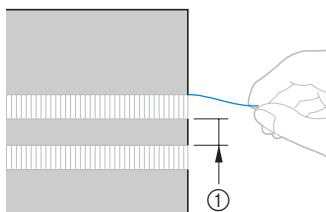

① 4 mm (3/16 inch)

- 2 Attach monogramming foot “N”.

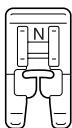

- For details, refer to “Replacing the presser foot” (page 37).

- 3 Select stitch <sup>36</sup> .

- For details, refer to “Selecting stitching” (page 68).

- 4 Sew along the center of the unfrayed section.

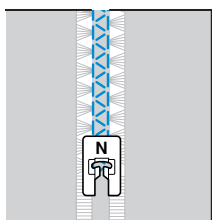

## Sewing the Various Built-In Decorative Patterns

Satin stitches, cross-stitches and decorative satin stitches can be sewn. All are sewn with monogramming foot “N”.

### Sewing beautiful patterns

In order to sew the patterns correctly, the following must be considered.

#### ■ Fabric

Before sewing stretch or thin fabrics or fabrics with a coarse weave, affix the optional stabilizer material to the wrong side of the fabric or place a thin sheet of paper, such as tracing paper, under the fabric. Since material puckering or bunched stitches may occur when satin stitches are sewn, be sure to affix stabilizer material to the fabric.

#### ■ Needles and threads

When sewing thin, mediumweight or stretch fabrics, use the ball point needle. When sewing thick fabrics, use a 90/14 home sewing machine needle. In addition, 75/11 to 90/14 thread should be used.

#### ■ Trial sewing

Depending on the type and thickness of the fabric being sewn and whether or not stabilizer material is used, the desired result may not be achieved. Be sure to sew a trial piece of fabric before sewing your project. In addition, while sewing, be sure to guide the fabric with your hands in order to prevent the fabric from slipping.

### Sewing patterns

#### 1 Attach monogramming foot “N”.

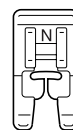

- For details, refer to “Replacing the presser foot” (page 37).

#### 2 Select a stitch.

- For details, refer to steps 4 through 9 of “Selecting stitching” (page 68).

#### 3 Start sewing.

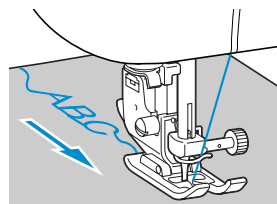
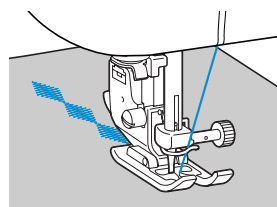

- The stitching is sewn in the direction indicated by the arrow.

- 4 Sew reinforcement stitches.** When sewing with a character stitch, reinforcement stitches are automatically sewn after each character.
- When sewing a pattern with a stitch other than a character stitch, it is useful to first set the automatic reverse/reinforcement stitching setting. For details, refer to “Automatically sewing reverse/reinforcement stitches” (page 57).
- 5** When you are finished sewing, use scissors to trim off any excess threads at the beginning of the stitching and between the patterns.

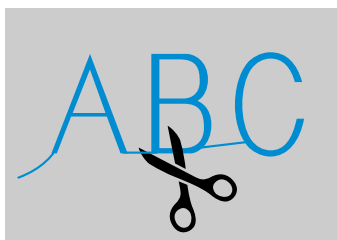

## Combining patterns

Multiple patterns can be combined and sewn together.

- 1 Select the first pattern, and then press (OK key).**
  - ▶ The first pattern is selected and appears in the LCD.
- 2 Press the + key in the operation panel.**
  - ▶ The screen for selecting a pattern appears again.
- 3 Select the next pattern, and then press (OK key).**



- When the sewing is started, the selected pattern is sewn repeatedly until the sewing machine is stopped.

- 2 Press the + key in the operation panel.**
  - ▶ The screen for selecting a pattern appears again.
- 3 Select the next pattern, and then press (OK key).**

To select a different stitch type, press  (stitch selection key).

(stitch selection key).

- ▶ The combined patterns appear in the LCD.



- To remove a selected pattern, press the C key in the operation panel. The pattern that was selected last is removed.

- 4 Repeat steps 2 and 3.**
- 5 After all of the desired patterns are selected, start sewing.**

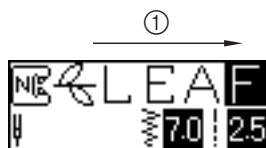

① Sewing direction

- ▶ The order that the patterns appear in the LCD is the order that they will be sewn.





### Memo

- Up to 70 patterns can be combined.
- Some utility stitches cannot be combined.
- If multiple patterns have been combined, the sewing machine stops once all the selected patterns displayed in the LCD have been sewn. To repeatedly sew the combined pattern, refer to “Repeat sewing patterns”.
- The combined pattern can be stored for later use. For details, refer to “Storing a pattern” (page 120).

## Repeat sewing patterns

To repeatedly sew the combined pattern, follow the procedure described below.

- 1 **Select the pattern.**
  - For details, refer to “Combining patterns” (on the previous page).





- 2 **Press  (settings key) in the operation panel.**
  - ▶ The settings screen appears.

- 3 **Press , ,  and  (arrow keys) until  is selected.**



- 4 **Press  (OK key).**

▶ The screen for specifying repeat sewing appears.

- 5 **Press  to select  (repeat sewing).**  
To return to  (single sewing), press .

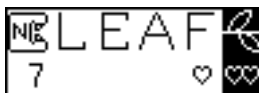

- 6 **Press  (OK key).**

▶ The initial stitch screen appears again, and the machine is set to repeatedly sew the selected pattern.

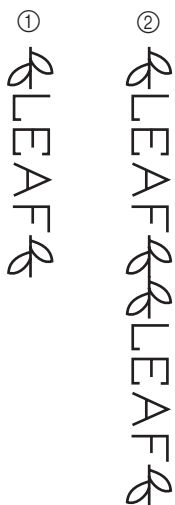

- ① Single
- ② Repeated



**Note**

- If repeated sewing is set, the pattern is repeatedly sewn until the sewing machine is stopped.
- If the sewing machine is turned off, the repeated/single sewing setting returns to its default setting.

### Checking the selected pattern

Up to 70 patterns can be combined. If all of the selected patterns cannot be displayed in the LCD at the same time, the pattern can be checked according to the following procedure.

- 1 Press (settings key) in the operation panel.
  - ▶ The settings screen appears.
- 2 Press , , and (arrow keys) until is selected.









- 3 Press (OK key).
  - ▶ The screen for checking the pattern appears.
- 4 Press and to scroll through the pattern and check it.







- 5 Press (OK key).
  - ▶ The initial stitch screen appears again.

## Changing the pattern size

The size of character stitches in the Gothic font and outline style can be switched between large and small. However, the size of other patterns cannot be changed.

- 1 Select a stitch.**  
Select a character stitch in either the Gothic font or outline style.
- 2 Press  (settings key) in the operation panel.**  
▶ The settings screen appears.
- 3 Press , ,  and  (arrow keys) until  is selected.**



- 4 Press  (OK key).**  
▶ The screen for changing the pattern size appears.
- 5 Press  and  until the desired size is selected.**  
Select  for the small size or select  for the large size.



- 6 Press  (OK key).**  
▶ The initial stitch screen appears again.

LEAFLEAF









### Memo



- The large pattern size is the default. If the small pattern size is selected, small patterns can be combined and connected.
- If multiple patterns have been combined, the size of each selected pattern can be specified.

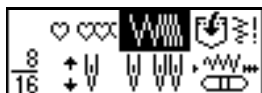

## Changing the stitch density

If a decorative satin stitch has been selected, the stitch density can be changed.

- 1 Select a decorative satin stitch .
- 2 Press  (settings key) in the operation panel.
  - ▶ The settings screen appears.
- 3 Press , ,  and  (arrow keys) until  is selected.



- 4 Press  (OK key).
  - ▶ The screen for specifying the stitching density of the decorative satin stitch appears.
- 5 Press  and  until the desired density is selected.

Select  for coarser stitching or select  for finer stitching.

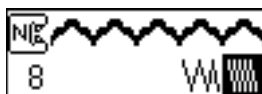







- 6 Press  (OK key).
  - ▶ The initial stitch screen appears again, and the stitching density is changed.

### ! CAUTION



- If the stitching density is too fine, depending on the needle, the stitches may be bunched together, causing the needle to break.

## Changing the pattern length

The length of one part of a satin stitch can be set to one of five sizes.

- 1 Select a satin stitch .
- 2 Press  (settings key) in the operation panel.
  - ▶ The settings screen appears.
- 3 Press , ,  and  (arrow keys) until  is selected.



- 4 Press  (OK key).
  - ▶ The screen for changing the length of a satin stitch appears.
- 5 Press  and  until the desired ratio is selected.

The length can be set within the range of  $\times 1$  and  $\times 5$ .







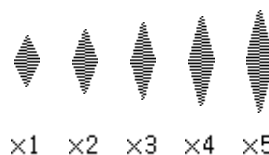

- ▶ The satin stitch length is changed.

- 6 Press  (OK key).
  - ▶ The initial stitch screen appears again.





## Mirror imaging the pattern

The pattern can be mirror imaged along a vertical axis.

- 1 Select a stitch.
- 2 Press  (settings key) in the operation panel.  
▶ The settings screen appears.
- 3 Press , ,  and  (arrow keys) until  is selected.



- 4 Press  (OK key).  
▶ The screen for mirror imaging the pattern appears.
- 5 Press  to select **ON**.  
To return to **OFF**, press .



▶ The pattern is mirror imaged.



- 6 Press  (OK key).  
▶ The initial stitch screen appears again.

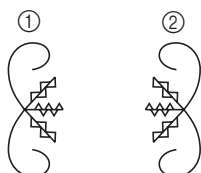

- ① Normal
- ② Mirror-imaged

## Memo

- Some of the utility and decorative patterns can be mirror imaged.
- Mirror imaged patterns can also be combined with other patterns.



## Storing a pattern

Combined patterns can be stored for later use. Since stored patterns are not lost after the sewing machine is turned off, they can be recalled at any time. This is convenient for patterns, such as names, that will be used often. Up to five patterns can be stored.

### ■ Storing a pattern

#### 1 Create the combined pattern that you wish to store.

- For details, refer to “Combining patterns” (page 114).



#### 2 Press (stitch selection key) in the operation panel.

- The screen containing the various types of stitches appears.



#### 3 Press , , and (arrow keys) until is selected.



#### 4 Press (OK key).

- The screen for selecting the storage location (pocket) appears.

#### 5 Press and until the pocket (1 through 5) where you wish to store the pattern is selected.

 indicates an empty pocket.  indicates a pocket where a pattern is already stored.



#### 6 Press (OK key).

- The contents of the selected pocket are displayed.

#### 7 Check the contents, and then press (OK key).

The contents stored in the  pocket are overwritten.

- “Saving...” appears while the pattern is being stored in the pocket.
- Do not turn off the sewing machine while a pattern is being stored, otherwise the pattern data may be lost.
- After the pattern is stored, the initial stitch screen appears again.

### ■ Recalling a pattern

#### 1 Press (stitch selection key) in the operation panel.

- The screen containing the various types of stitches appears.

#### 2 Press , , and (arrow keys) until is selected.



#### 3 Press (OK key).

- The screen for selecting a pocket appears.

#### 4 Press and until the pocket containing the pattern that you wish to recall is selected.

A pattern is stored in the  pocket.



**5** Press  (OK key).

- ▶ The contents of the selected pocket are displayed.

**6** Check the contents, and then press  (OK key).



To select a different pocket, press  (back key).

- ▶ The initial stitch screen appears again, and the pattern from the selected pocket is recalled.

## Realigning the pattern

The pattern may not be sewn correctly, depending on the type of fabric being sewn or the sewing speed. If this occurs, adjust the pattern while sewing on a piece of scrap fabric that is the same as that used for your project.



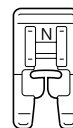



**1** Attach monogramming foot “N”.



- For details, refer to “Replacing the presser foot” (page 37).

**2** Press  (stitch selection key) in the operation panel.

- ▶ The screen containing the various types of stitches appears.

**3** Press , ,  and  (arrow keys) until  is selected, and then select .



- ▶ The pattern alignment stitch is selected.

**4** Start sewing.



- ▶ The pattern for making the adjustment is sewn.
- ▶ The sewing machine stops after it has finished sewing the pattern.

**5 Check the sewn pattern.**

If the part of the pattern indicated in the illustration is sewn uniformly, the pattern is correctly aligned.

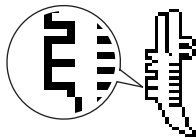

If the pattern is not sewn correctly, following the steps below to adjust the sewing.

**6 Press  (settings key) in the operation panel.**

▶ The settings screen appears.

**7 Press , ,  and  (arrow keys) until  is selected.**



**8 Press  (OK key).**

▶ The screen for adjusting the pattern appears.

**9 Press  (-) or  (+).**



▶ Make the necessary adjustments according to how the pattern is sewn.

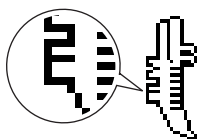

Press  to increase the adjustment setting.

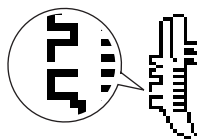

Press  to decrease the adjustment setting.

**10 Start sewing again, and then check the pattern.**

Continue adjusting the pattern until it is sewn correctly.

**11 When the pattern is sewn correctly, press  (OK key).**

▶ The initial stitch screen appears again.



# Designing a Pattern

With the My Custom Stitch function, you can sew stitch patterns that you design yourself.

## Drawing a sketch of the pattern

Prepare a grid sheet set.



- 1 Draw a sketch of the pattern on the grid sheet set.

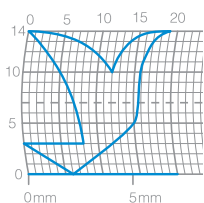

Draw the pattern as one continuous line and with the start point and the end point of the design at the same height.



- 2 If the pattern will be repeated, determine the space between the repeating patterns.

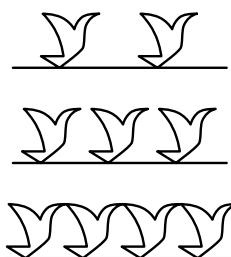
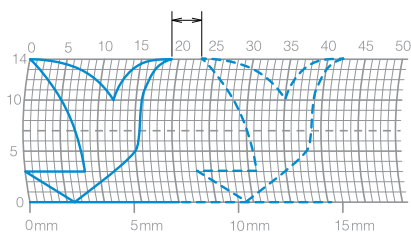

- 3 Mark the points in the pattern that are positioned at intersections in the grid, and then link those points with a continuous straight line.

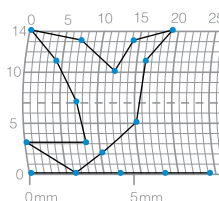

- 4 Determine the sewing order.

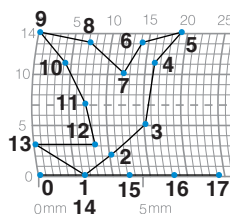

For a more attractive stitch, close the pattern by intersecting the line.

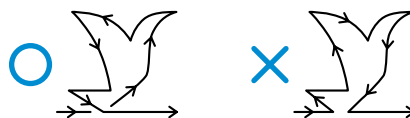

## Entering the pattern data

Follow the pattern drawn on the grid sheet and program the pattern into the sewing machine.

### 1 Attach monogramming foot "N".

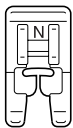

- For details, refer to "Replacing the presser foot" (page 37).

### 2 Turn on the sewing machine.

### 3 Press (stitch selection key) in the operation panel.

- The screen containing the various types of stitches appears.



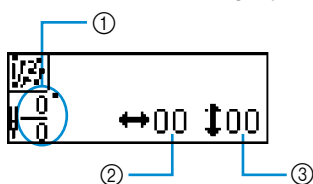

### 4 Press , , and (arrow keys) until is selected, and then press (OK key).

- The screen for entering a pattern appears.



- Number of the current point/Total number of points
- Horizontal coordinate (0-75)
- Vertical coordinate (0-14)

### 5 Check the grid sheet set, and specify the coordinates of the first point.

Press  and  to select the horizontal coordinate and press  and  to select the vertical coordinate, and then press  (OK key).

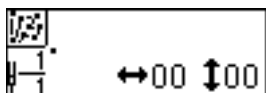



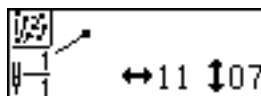

### 6 Specify the coordinates of the second point, and then press (OK key).



- A screen appears, allowing you to specify the settings for the stitching between the two points.

### 7 Specify whether single stitching or triple stitching will be sewn between the points.

Press  and  to select  for single stitching or  for triple stitching, and then press  (OK key).

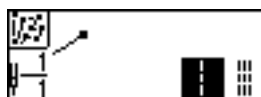

- A screen for selecting the next operation appears.

### 8 Select , and then press (OK key).

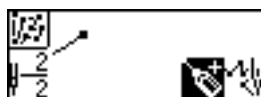

- If you make a mistake while specifying a point, press the C key to erase the last point specified.
- A screen for specifying the next point appears.

### 9 Repeat steps 6 through 8 to specify each point.

Up to 99 points can be entered.

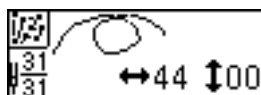

### 10 After all points in the pattern have been specified, select in the screen that appears in step 8, and then press (OK key).

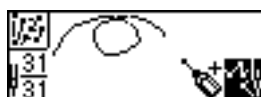

► The embroidery screen appears.

- 11** Specify the various stitching settings, such as reverse/reinforcement stitching, in the same way as with other stitches.



- With this screen displayed, pressing  (back key) allows you to add or remove points.

### Memo

- To store the entered pattern data, store it from the embroidery screen. For details, refer to “Storing a pattern” (page 120).
- The pattern in the LCD will appear different from the pattern drawn in the grid sheet set and the actual sewn stitch. Also, refer to these when entering the design.

## Design exemplified

Enter each of the points indicated in the table to sew the sample stitch.



Point	↔	↑↓	Point	↔	↑↓
0	0	0	20	38	13
1	12	0	21	35	14
2	18	3	22	32	13
3	22	6	23	30	10
4	23	10	24	32	6
5	21	13	25	35	3
6	17	14	26	41	0
7	14	13	27	45	0
8	12	11	28	47	4
9	9	13	29	44	7
10	6	14	30	45	11
11	3	13	31	47	13
12	1	10	32	50	14
13	3	6	33	54	13
14	6	3	34	56	10
15	12	0	35	55	6
16	41	0	36	51	3
17	43	4	37	45	0
18	40	7	38	70	0
19	41	11			

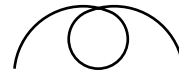

Point	↔	↑↓	Point	↔	↑↓
0	0	0	20	16	10
1	3	5	21	18	12
2	5	8	22	21	13
3	8	11	23	25	14
4	12	13	24	28	14
5	17	14	25	33	13
6	20	14	26	37	11
7	24	13	27	41	8
8	27	12	28	43	5
9	29	11	29	44	0
10	31	9			
11	32	6			
12	30	3			
13	27	1			
14	24	0			
15	21	0			
16	18	1			
17	16	3			
18	15	5			
19	15	8			



Point	↔	↑↓	Point	↔	↑↓
0	0	0	20	10	11
1	30	0	21	12	10
2	32	1	22	8	9
3	32	7	23	12	8
4	32	10	24	7	6
5	33	12	25	12	6
6	35	11	26	6	3
7	35	8	27	10	2
8	37	12	28	5	0
9	35	14	29	10	2
10	32	14	30	16	1
11	30	11	31	19	0
12	30	5	32	23	0
13	29	3	33	22	6
14	26	8	34	17	10
15	24	10	35	22	6
16	18	13	36	23	0
17	13	14	37	19	0
18	12	14	38	42	0
19	13	12			



Point	↔	↑↓	Point	↔	↑↓
0	0	7	20	20	11
1	5	7	21	21	7
2	4	3	22	24	7
3	5	7	23	23	14
4	8	7	24	24	7
5	7	0	25	27	7
6	8	7	26	27	11
7	11	7	27	27	7
8	11	3	28	32	7
9	11	7	29	27	11
10	16	7	30	23	14
11	11	3	31	20	11
12	7	0	32	16	7
13	4	3	33	20	3
14	0	7	34	23	0
15	4	11	35	27	3
16	7	14	36	32	7
17	11	11			
18	16	7			
19	21	7			

4

# APPENDIX









The various maintenance and troubleshooting procedures are described in this chapter.



















Stitch Settings .....	128
Maintenance .....	135
Troubleshooting .....	137
Index .....	144

## Stitch Settings

Applications, stitch lengths and widths and whether the twin needle can be used are listed for utility stitches in the following table.





















### Utility stitches







Stitch Name	Pattern	Presser Foot	Application	Stitch Width [mm (inch.)]		Stitch Length [mm (inch.)]		Twin Needle	Reverse/Reinforcement Stitching	Programmed Thread-Cutting	Walking Foot
				Auto	Manual	Auto	Manual				
Straight stitch	Left 	J	Basic stitching, sewing gathers or pintucks, etc.	0.0 (0)	0.0–7.0 (0–1/4)	2.5 (3/32)	0.2–5.0 (1/64–3/16)	Yes	Reverse	Reverse + thread-cutting	No
				0.0 (0)	0.0–7.0 (0–1/4)	2.5 (3/32)	0.2–5.0 (1/64–3/16)	Yes	Reinforcement	Reinforcement + thread-cutting	Yes
	Center 	J/I	Attaching zippers, basic stitching, sewing gathers or pintucks, etc.	–	–	2.5 (3/32)	0.2–5.0 (1/64–3/16)	Yes	Reverse	Reverse + thread-cutting	No
Triple stretch stitch		J	Attaching sleeves, sewing inseams, sewing stretch fabrics and decorative stitching	0.0 (0)	0.0–7.0 (0–1/4)	2.5 (3/32)	1.5–4.0 (1/16–3/16)	Yes	Reinforcement	Reinforcement + thread-cutting	No
Stretch stitch		J	Sewing stretch fabrics and decorative stitching	1.0 (1/16)	1.0–3.0 (1/16–1/8)	2.5 (3/32)	1.0–4.0 (1/16–3/16)	Yes	Reinforcement	Reinforcement + thread-cutting	No
Basting stitch		J	Temporarily securing	0.0 (0)	0.0–7.0 (0–1/4)	–	–	No	Reinforcement	Reinforcement + thread-cutting	No
Zigzag stitch	Center 	J	Overcasting and attaching appliqués	3.5 (1/8)	0.0–7.0 (0–1/4)	1.4 (1/16)	0.0–4.0 (0–3/16)	Yes	Reverse	Reverse + thread-cutting	No
	Right 	J	Beginning sewing from the right needle position	3.5 (1/8)	2.5–5.0 (3/32–3/16)	1.4 (1/16)	0.3–4.0 (1/64–3/16)	Yes	Reinforcement	Reinforcement + thread-cutting	Yes
2-point zigzag stitch		J	Overcasting on mediumweight or stretch fabrics, attaching elastic, darning, etc.	5.0 (3/16)	1.5–7.0 (1/16–1/4)	1.0 (1/16)	0.2–4.0 (1/64–3/16)	Yes	Reinforcement	Reinforcement + thread-cutting	Yes
3-point zigzag stitch		J	Overcasting on mediumweight or stretch fabrics, attaching elastic, darning, etc.	5.0 (3/16)	1.5–7.0 (1/16–1/4)	1.0 (1/16)	0.2–4.0 (1/64–3/16)	Yes	Reinforcement	Reinforcement + thread-cutting	No

Stitch Name	Pattern	Presser Foot	Application	Stitch Width [mm (inch.)]		Stitch Length [mm (inch.)]		Twin Needle	Reverse/ Reinforcement Stitching	Programmed Thread-Cutting	Walking Foot
				Auto	Manual	Auto	Manual				
Overcasting stitch	11 	G	Overcasting on thin or mediumweight fabrics	3.5 (1/8)	2.5–5.0 (3/32–3/16)	2.0 (1/16)	1.0–4.0 (1/16–3/16)	No	Reinforce- ment	Reinforce- ment + thread-cut- ting	No
	12 	G	Overcasting on thick fabrics	5.0 (3/16)	2.5–5.0 (3/32–3/16)	2.5 (3/32)	1.0–4.0 (1/16–3/16)	No	Reinforce- ment	Reinforce- ment + thread-cut- ting	No
	13 	G	Overcasting on thick fabrics and decorative stitching	5.0 (3/16)	3.5–5.0 (1/8–3/16)	2.5 (3/32)	1.0–4.0 (1/16–3/16)	No	Reinforce- ment	Reinforce- ment + thread-cut- ting	No
	14 	J	Overcasting on stretch fabrics	5.0 (3/16)	0.0–7.0 (0–1/4)	2.5 (3/32)	0.5–4.0 (1/32–3/16)	Yes	Reinforce- ment	Reinforce- ment + thread-cut- ting	No
	15 	J	Overcasting on thick or stretch fabrics	5.0 (3/16)	0.0–7.0 (0–1/4)	2.5 (3/32)	0.5–4.0 (1/32–3/16)	Yes	Reinforce- ment	Reinforce- ment + thread-cut- ting	No
	16 	J	Overcasting on stretch fabrics and decorative stitching	4.0 (3/16)	0.0–7.0 (0–1/4)	4.0 (3/16)	1.0–4.0 (1/16–3/16)	Yes	Reinforce- ment	Reinforce- ment + thread-cut- ting	No
Blind hem stitch	17 	R	Blind hem stitching on mediumweight fabrics	0.0 (0)	3← – 3→	2.0 (1/16)	1.0–3.5 (1/16–1/8)	No	Reinforce- ment	Reinforce- ment + thread-cut- ting	No
	18 	R	Blind hem stitching on stretch fabrics	0.0 (0)	3← – 3→	2.0 (1/16)	1.0–3.5 (1/16–1/8)	No	Reinforce- ment	Reinforce- ment + thread-cut- ting	No
Appliqué stitch	19 	J	Appliqué stitching	3.5 (1/8)	2.5–5.0 (3/32–3/16)	2.5 (3/32)	1.6–4.0 (1/16–3/16)	Yes	Reinforce- ment	Reinforce- ment + thread-cut- ting	No
Shell tuck stitch	20 	J	Shell tuck stitching	4.0 (3/16)	0.0–7.0 (0–1/4)	2.5 (3/32)	0.2–4.0 (1/64–3/16)	Yes	Reinforce- ment	Reinforce- ment + thread-cut- ting	No
Satin scallop stitch	21 	N	Scallop stitching	5.0 (3/16)	2.5–7.0 (3/32–1/4)	0.5 (1/32)	0.1–1.0 (1/64–1/16)	Yes	Reinforce- ment	Reinforce- ment + thread-cut- ting	No
Joining stitch	22 	J	Patchwork stitching and decorative stitching	4.0 (3/16)	0.0–7.0 (0–1/4)	1.2 (1/16)	0.2–4.0 (1/64–3/16)	Yes	Reinforce- ment	Reinforce- ment + thread-cut- ting	No
	23 	J	Patchwork stitching, decorative stitching and sewing overcasting on both pieces of fabric, such as with tricot	5.0 (3/16)	2.5–7.0 (3/32–1/4)	2.5 (3/32)	1.0–4.0 (1/16–3/16)	Yes	Reinforce- ment	Reinforce- ment + thread-cut- ting	No
	24 	J	Patchwork stitching and decorative stitching	5.0 (3/16)	0.0–7.0 (0–1/4)	1.2 (1/16)	0.2–4.0 (1/64–3/16)	Yes	Reinforce- ment	Reinforce- ment + thread-cut- ting	No
Smocking stitch	25 	J	Smocking stitching and decorative stitching	5.0 (3/16)	0.0–7.0 (0–1/4)	1.6 (1/16)	1.0–4.0 (1/16–3/16)	Yes	Reinforce- ment	Reinforce- ment + thread-cut- ting	No
Fagoting stitch	26 	J	Fagoting and decorative stitching	5.0 (3/16)	0.0–7.0 (0–1/4)	2.5 (3/32)	1.0–4.0 (1/16–3/16)	Yes	Reinforce- ment	Reinforce- ment + thread-cut- ting	No
	27 	J	Fagoting and decorative stitching	5.0 (3/16)	2.5–7.0 (3/32–1/4)	2.5 (3/32)	1.0–4.0 (1/16–3/16)	Yes	Reinforce- ment	Reinforce- ment + thread-cut- ting	No
Elastic-attach- ing stitch	28 	J	Attaching elastic to stretch fabrics	4.0 (3/16)	0.0–7.0 (0–1/4)	1.0 (1/16)	0.2–4.0 (1/64–3/16)	Yes	Reinforce- ment	Reinforce- ment + thread-cut- ting	No

Stitch Name	Pattern	Presser Foot	Application	Stitch Width [mm (inch.)]		Stitch Length [mm (inch.)]		Twin Needle	Reverse/Reinforcement Stitching	Programmed Thread-Cutting	Walking Foot
				Auto	Manual	Auto	Manual				
Decorative stitch	29	J	Decorative stitching	4.0 (3/16)	0.0–7.0 (0–1/4)	3.0 (1/8)	2.0–4.0 (1/16–3/16)	No	Reinforcement	Reinforcement + thread-cutting	No
	30	J	Decorative stitching	4.0 (3/16)	0.0–7.0 (0–1/4)	2.5 (3/32)	1.0–4.0 (1/16–3/16)	Yes	Reinforcement	Reinforcement + thread-cutting	No
	31	J	Decorative stitching	5.5 (7/32)	0.0–7.0 (0–1/4)	1.6 (1/16)	1.0–4.0 (1/16–3/16)	Yes	Reinforcement	Reinforcement + thread-cutting	No
	32	N	Decorative stitching and elastic-attaching	5.0 (3/16)	1.5–7.0 (1/16–1/4)	1.0 (1/16)	0.2–4.0 (1/64–3/16)	Yes	Reinforcement	Reinforcement + thread-cutting	No
	33	N	Lace sewing, decorative hemming, heirloom stitching, etc.	3.5 (1/8)	1.5–7.0 (1/16–1/4)	2.5 (3/32)	1.6–4.0 (1/16–3/16)	No	Reinforcement	Reinforcement + thread-cutting	No
	34	N	Decorative hemming, heirloom stitching, etc.	6.0 (15/64)	1.5–7.0 (1/16–1/4)	3.0 (1/8)	1.5–4.0 (1/16–3/16)	No	Reinforcement	Reinforcement + thread-cutting	No
	35	N	Decorative hemming on thin, mediumweight and plain weave fabrics, heirloom stitching, etc.	5.0 (3/16)	1.5–7.0 (1/16–1/4)	3.5 (1/8)	1.5–4.0 (1/16–3/16)	No	Reinforcement	Reinforcement + thread-cutting	No
	36	N	Decorative hemming on thin, mediumweight and plain weave fabrics, heirloom stitching, etc.	5.0 (3/16)	1.5–7.0 (1/16–1/4)	4.0 (3/16)	1.5–4.0 (1/16–3/16)	Yes	Reinforcement	Reinforcement + thread-cutting	No
	37	N	Decorative hemming on thin, mediumweight and plain weave fabrics, heirloom stitching, etc.	5.0 (3/16)	1.5–7.0 (1/16–1/4)	2.5 (3/32)	1.5–4.0 (1/16–3/16)	Yes	Reinforcement	Reinforcement + thread-cutting	No
	38	N	Decorative hemming on thin, mediumweight and plain weave fabrics, heirloom stitching, etc.	5.0 (3/16)	1.5–7.0 (1/16–1/4)	2.0 (1/16)	1.5–4.0 (1/16–3/16)	Yes	Reinforcement	Reinforcement + thread-cutting	No
	39	N	Decorative hemming, ribbon threading, heirloom stitching, etc.	5.0 (3/16)	1.5–7.0 (1/16–1/4)	3.0 (1/8)	1.5–4.0 (1/16–3/16)	Yes	Reinforcement	Reinforcement + thread-cutting	No
	40	N	Decorative stitching, smocking stitching, heirloom stitching, etc.	6.0 (15/64)	1.5–7.0 (1/16–1/4)	1.6 (1/16)	1.0–4.0 (1/16–3/16)	No	Reinforcement	Reinforcement + thread-cutting	No
41	N	Decorative stitching, smocking stitching, heirloom stitching, etc.	5.0 (3/16)	1.5–7.0 (1/16–1/4)	1.6 (1/16)	1.0–4.0 (1/16–3/16)	No	Reinforcement	Reinforcement + thread-cutting	No	



Stitch Name	Pattern	Presser Foot	Application	Stitch Width [mm (inch.)]		Stitch Length [mm (inch.)]		Twin Needle	Reverse/Reinforcement Stitching	Programmed Thread-Cutting	Walking Foot
				Auto	Manual	Auto	Manual				
Buttonhole stitch	42 	A	Horizontal buttonholes on thin and mediumweight fabrics	5.0 (3/16)	3.0–5.0 (1/8–3/16)	0.4 (1/64)	0.2–1.0 (1/64–1/16)	No	Automatic reinforcement	Thread-cutting	No
	43 	A	Horizontal buttonholes on areas that are subject to strain	5.0 (3/16)	3.0–5.0 (1/8–3/16)	0.4 (1/64)	0.2–1.0 (1/64–1/16)	No	Automatic reinforcement	Thread-cutting	No
	44 	A	Horizontal buttonholes on thick fabrics	5.0 (3/16)	3.0–5.0 (1/8–3/16)	0.4 (1/64)	0.2–1.0 (1/64–1/16)	No	Automatic reinforcement	Thread-cutting	No
	45 	A	Secured buttonholes for fabrics that have backings	5.0 (3/16)	3.0–5.0 (1/8–3/16)	0.4 (1/64)	0.2–1.0 (1/64–1/16)	No	Automatic reinforcement	Thread-cutting	No
	46 	A	Buttonholes for stretch or knit fabrics	6.0 (15/54)	3.0–6.0 (1/8–15/64)	1.0 (1/16)	0.5–2.0 (1/32–1/16)	No	Automatic reinforcement	Thread-cutting	No
	47 	A	Buttonholes for stretch fabrics	6.0 (15/54)	3.0–6.0 (1/8–15/64)	1.5 (1/16)	1.0–3.0 (1/16–1/8)	No	Automatic reinforcement	Thread-cutting	No
	48 	A	Bound buttonholes	5.0 (3/16)	0.0–6.0 (0–15/64)	2.0 (1/16)	0.2–4.0 (1/64–3/16)	No	Automatic reinforcement	Thread-cutting	No
	49 	A	Keyhole buttonholes for thick or furry fabrics	7.0 (1/4)	3.0–7.0 (1/8–1/4)	0.5 (1/32)	0.3–1.0 (1/64–1/16)	No	Automatic reinforcement	Thread-cutting	No
	50 	A	Keyhole buttonholes for mediumweight and thick fabrics	7.0 (1/4)	3.0–7.0 (1/8–1/4)	0.5 (1/32)	0.3–1.0 (1/64–1/16)	No	Automatic reinforcement	Thread-cutting	No
	51 	A	Horizontal buttonholes for thick or furry fabrics	7.0 (1/4)	3.0–7.0 (1/8–1/4)	0.5 (1/32)	0.3–1.0 (1/64–1/16)	No	Automatic reinforcement	Thread-cutting	No
Darning stitch	52 	A	Darning mediumweight fabrics	7.0 (1/4)	2.5–7.0 (3/32–1/4)	2.0 (1/16)	0.4–2.5 (1/64–3/32)	No	Automatic reinforcement	Thread-cutting	No
	53 	A	Darning thick fabrics	7.0 (1/4)	2.5–7.0 (3/32–1/4)	2.0 (1/16)	0.4–2.5 (1/64–3/32)	No	Automatic reinforcement	Thread-cutting	No
Bar tack stitch	54 	A	Reinforcing openings and areas where the seam easily comes loose	2.0 (1/16)	1.0–3.0 (1/16–1/8)	0.4 (1/64)	0.3–1.0 (1/64–1/16)	No	Automatic reinforcement	Thread-cutting	No
Button-sewing stitch	55 	M	Button sewing	3.5 (1/8)	2.5–4.5 (3/32–3/16)	–	–	No	Reinforcement	Reinforcement + thread-cutting	No
Eyelet stitch	56 	N	Sewing eyelets, for example, on belts	7.0 (1/4)	7.0, 6.0, 5.0 (1/4, 15/64, 3/16)	7.0 (1/4)	7.0, 6.0, 5.0 (1/4, 15/64, 3/16)	No	Automatic reinforcement	Thread-cutting	No
Piecing straight stitch	57 	J	Piecing straight stitching (with a seam allowance of 6.5 mm from the right edge of the presser foot)	5.5 (7/32)	0.0–7.0 (0–1/4)	1.6 (1/16)	0.2–5.0 (1/64–3/16)	No	Reinforcement	Reinforcement + thread-cutting	No
	58 	J	Piecing straight stitching (with a seam allowance of 6.5 mm from the left edge of the presser foot)	1.5 (1/16)	0.0–7.0 (0–1/4)	1.6 (1/16)	0.2–5.0 (1/64–3/16)	No	Reinforcement	Reinforcement + thread-cutting	Yes
Straight stitch that looks hand-sewn (for quilting)	59 	J	Straight stitch quilting that looks hand-sewn	0.0 (0)	0.0–7.0 (0–1/4)	2.5 (3/32)	1.0–4.0 (1/16–3/16)	No	Reinforcement	Reinforcement + thread-cutting	No
Zigzag stitch (for quilting)	60 	J	Appliqué quilting, free-motion quilting, satin stitching	3.5 (1/8)	0.0–7.0 (0–1/4)	1.4 (1/16)	0.0–4.0 (0–3/16)	No	Reinforcement	Reinforcement + thread-cutting	Yes
Appliqué stitch (for quilting)	61 	J	Attaching appliqués and binding	1.5 (1/16)	0.5–5.0 (1/32–3/16)	1.2 (1/16)	1.0–4.0 (1/16–3/16)	No	Reinforcement	Reinforcement + thread-cutting	No

Stitch Name	Pattern	Presser Foot	Application	Stitch Width [mm (inch.)]		Stitch Length [mm (inch.)]		Twin Needle	Reverse/Reinforcement Stitching	Programmed Thread-Cutting	Walking Foot
				Auto	Manual	Auto	Manual				
Quilting stitch (for stippling)	62 	J	Quilting background stitching (stippling)	7.0 (1/4)	1.0–7.0 (1/16–1/4)	1.6 (1/16)	1.0–4.0 (1/16–3/16)	No	Reinforcement	Reinforcement + thread-cutting	No
Side cutter	63 	S	Sewing straight stitches while cutting the fabric	0.0 (0)	0.0–2.5 (0–3/32)	2.5 (3/32)	0.2–5.0 (1/64–3/16)	No	Reinforcement	Reinforcement + thread-cutting	No
	64 	S	Sewing zigzag stitches while cutting the fabric	3.5 (1/8)	3.5–5.0 (1/8–3/16)	1.4 (1/16)	0.0–4.0 (0–3/16)	No	Reinforcement	Reinforcement + thread-cutting	No
	65 	S	Overcasting on thin and mediumweight fabrics while cutting the fabric	3.5 (1/8)	3.5–5.0 (1/8–3/16)	2.0 (1/16)	1.0–4.0 (1/16–3/16)	No	Reinforcement	Reinforcement + thread-cutting	No
	66 	S	Overcasting on thick fabrics while cutting the fabric	5.0 (3/16)	3.5–5.0 (1/8–3/16)	2.5 (3/32)	1.0–4.0 (1/16–3/16)	No	Reinforcement	Reinforcement + thread-cutting	No
	67 	S	Overcasting on mediumweight and thick fabrics while cutting the fabric	5.0 (3/16)	3.5–5.0 (1/8–3/16)	2.5 (3/32)	1.0–4.0 (1/16–3/16)	No	Reinforcement	Reinforcement + thread-cutting	No

## Other stitches

Stitch Type	Pattern										Presser Foot	Twin Needle	Pattern Size	Adjustable Stitching Density	Adjustable Pattern Length/width	Left/Right Flipping
Decorative stitches	1	2	3	4	5	6	7	8	9	10	N	No	Large	No	Yes	Yes
	11	12	13	14	15	16	17	18	19	20						
	21	22	23	24	25	26	27	28	29	30						
	31*															
Satin stitches	1	2	3	4	5	6	7	8	9	10	N	Yes	Large	No	Yes	Yes
	11	12	13	14	15	16										
Cross-stitches	1	2	3	4	5						N	No	Large	No	Yes	Yes
Decorative satin stitches	1	2	3	4	5	6	7	8	9	10	N	No	Large	Yes	Yes (length only)	Yes
Character stitches (Gothic font)	1	2	3	4	5	6	7	8	9	10	N	No	Large, Small	No	No	Yes
	11	12	13	14	15	16	17	18	19	20						
	21	22	23	24	25	26	27	28	29	30						
	31	32	33	34	35	36	37	38	39	40						
	41	42	43	44	45	46	47	48	49	50						
	51	52	53	54	55											

\*Pattern for making adjustment

Stitch Type	Pattern										Presser Foot	Twin Needle	Pattern Size	Adjustable Stitching Density	Adjustable Pattern Length/width	Left/Right Flipping
	1	2	3	4	5	6	7	8	9	10						
Character stitches (Script font)	1	2	3	4	5	6	7	8	9	10	N	No	Large	No	No	Yes
	<i>A</i>	<i>B</i>	<i>C</i>	<i>D</i>	<i>E</i>	<i>F</i>	<i>G</i>	<i>H</i>	<i>I</i>	<i>J</i>						
	11	12	13	14	15	16	17	18	19	20						
	<i>K</i>	<i>L</i>	<i>M</i>	<i>N</i>	<i>O</i>	<i>P</i>	<i>Q</i>	<i>R</i>	<i>S</i>	<i>T</i>						
	21	22	23	24	25	26	27	28	29	30						
	<i>U</i>	<i>V</i>	<i>W</i>	<i>X</i>	<i>Y</i>	<i>Z</i>	<i>&amp;</i>	<i>?</i>	<i>!</i>	<i>-</i>						
31	32	33	34	35	36	37	38	39	40	N	No	Large, Small	No	No	Yes	
<i>0</i>	<i>1</i>	<i>2</i>	<i>3</i>	<i>4</i>	<i>5</i>	<i>6</i>	<i>7</i>	<i>8</i>	<i>9</i>							
41	42	43	44	45	46	47	48	49	50							
<i>,</i>	<i>,</i>	<i>.</i>	<i>(</i>	<i>)</i>	<i>-</i>	<i>À</i>	<i>Á</i>	<i>Æ</i>	<i>Ñ</i>							
51	52	53	54	55												
<i>Ö</i>	<i>Ø</i>	<i>Ç</i>	<i>Ù</i>	<i>ß</i>												
Character stitches (Outline style)	1	2	3	4	5	6	7	8	9	10	N	No	Large, Small	No	No	Yes
	<b>A</b>	<b>B</b>	<b>C</b>	<b>D</b>	<b>E</b>	<b>F</b>	<b>G</b>	<b>H</b>	<b>I</b>	<b>J</b>						
	11	12	13	14	15	16	17	18	19	20						
	<b>K</b>	<b>L</b>	<b>M</b>	<b>N</b>	<b>O</b>	<b>P</b>	<b>Q</b>	<b>R</b>	<b>S</b>	<b>T</b>						
	21	22	23	24	25	26	27	28	29	30						
	<b>U</b>	<b>V</b>	<b>W</b>	<b>X</b>	<b>Y</b>	<b>Z</b>	<b>&amp;</b>	<b>?</b>	<b>!</b>	<b>-</b>						
31	32	33	34	35	36	37	38	39	40	N	No	Large, Small	No	No	Yes	
<b>0</b>	<b>1</b>	<b>2</b>	<b>3</b>	<b>4</b>	<b>5</b>	<b>6</b>	<b>7</b>	<b>8</b>	<b>9</b>							
41	42	43	44	45	46	47	48	49	50							
<b>,</b>	<b>,</b>	<b>.</b>	<b>(</b>	<b>)</b>	<b>-</b>	<b>À</b>	<b>Á</b>	<b>Æ</b>	<b>Ñ</b>							
51	52	53	54	55												
<b>Ö</b>	<b>Ø</b>	<b>Ç</b>	<b>Ù</b>	<b>ß</b>												

CONTENTS

GETTING READY

SEWING BASICS

UTILITY STITCHES

APPENDIX

INDEX

## Maintenance

Simple sewing machine maintenance operations are described below.

### Cleaning the machine surface

If the surface of the machine is dirty, lightly soak a cloth in neutral detergent, squeeze it out firmly, and then wipe the surface of the machine. After cleaning it once with a wet cloth, wipe it again with a dry cloth.

#### CAUTION

- Unplug the power supply cord before cleaning the machine, otherwise injuries or an electric shock may occur.

### Cleaning the shuttle

Sewing performance will suffer if dust collects in the shuttle; therefore, it should be cleaned periodically.

- 1 Turn off the sewing machine.

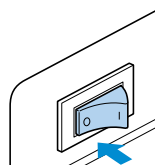

#### CAUTION

- Unplug the power supply cord before cleaning the machine, otherwise injuries or an electric shock may occur.

- 2 Grasp both sides of the needle plate cover, and then slide it toward you.

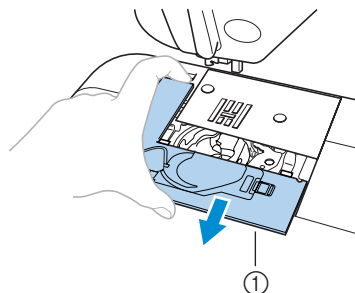

- ① Needle plate cover  
▶ The needle plate cover is removed.

- 3** Turn the balance wheel toward you until the tip of the shuttle hook aligns with the edge of the race shelf.

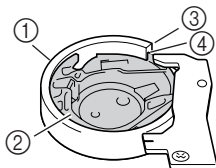

- ① Shuttle race
- ② Shuttle
- ③ Edge of the shuttle race
- ④ Tip of the shuttle hook

- Be sure to turn the balance wheel toward you. Turning the balance wheel away from you may damage the machine.

- 4** Remove the shuttle. Grasp the shuttle, and then pull it out.

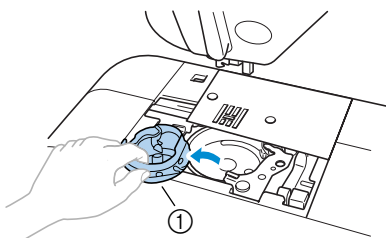

- ① Shuttle

- 5** Use the cleaning brush or a vacuum cleaner to remove any lint and dust from the race and its surrounding area.

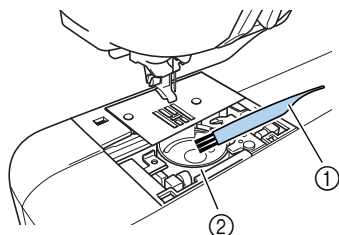

- ① Cleaning brush
- ② Shuttle race

- Do not apply oil to the shuttle.

- 6** Check that the edge of the race shelf is positioned as in step 3, and then insert the shuttle so that the projection on the shuttle aligns with the spring.

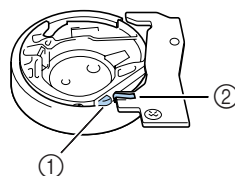
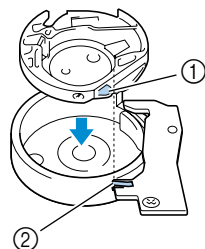

- ① Projection
- ② Spring

- 7** Insert the tabs on the needle plate cover into the needle plate, and then slide the cover back on.

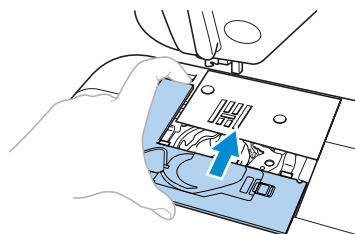

### ! CAUTION

- Never use a shuttle that is scratched, otherwise the upper thread may become tangled, the needle may break or sewing performance may suffer. For a new shuttle (part code: XC3153-051), contact your nearest authorized service center.
- Be sure that the shuttle is correctly installed, otherwise the needle may break.

## Troubleshooting

If the machine stops operating correctly, check the following possible problems before requesting service. If the problem persists, contact your retailer or the nearest authorized service center.

Symptom	Probable Cause	Remedy	Reference
<b>The sewing machine does not operate.</b>	The machine is not turned on.	Turn on the machine.	page 11
	The start/stop button was not pressed.	Press the start/stop button.	page 49
	The presser foot lever is raised.	Lower the presser foot lever.	–
	The start/stop button was pressed, even though the foot controller is connected.	Do not use the start/stop button when the foot controller is connected. To use the start/stop button, disconnect the foot controller.	page 49
<b>The needle breaks.</b>	The needle is incorrectly installed.	Correctly install the needle.	page 35
	The needle clamp screw is loose.	Use the screwdriver to firmly tighten the screw.	
	The needle is bent or blunt.	Replace the needle.	
	The combination of fabric, thread and needle is not correct.	Select a thread and needle that are appropriate for the type of fabric being sewn.	page 33
	The presser foot that is used is not appropriate for the type of stitch that you wish to sew.	Attach the presser foot that is appropriate for the type of stitch that you wish to sew.	page 128
	The upper thread tension is too tight.	Loosen the upper thread tension.	page 54
	The fabric is pulled too much.	Lightly guide the fabric.	–
	The spool is incorrectly installed.	Correctly install the spool.	page 24
	The area around the hole in the needle plate is scratched, or has a burr on it.	Replace the needle plate. Contact your retailer or the nearest authorized service center.	–
	The area around the hole in the presser foot is scratched, or has a burr on it.	Replace the presser foot. Contact your retailer or the nearest authorized service center.	–
The shuttle is scratched, or has a burr on it.	Replace the shuttle. Contact your retailer or the nearest authorized service center.	–	
A bobbin designed specifically for this machine is not used.	Incorrect bobbins will not work properly. Only use a bobbin designed specifically for this machine.	page 18	

Symptom	Probable Cause	Remedy	Reference
<b>The upper thread breaks.</b>	The upper thread was not threaded correctly (for example, the spool is not installed correctly, the spool cap is too big for the spool being used, or the thread has come out of the needle bar thread hook).	Correct the upper threading.	page 24
	There are knots or tangles in the thread.	Remove any knots or tangles.	–
	The selected needle is not appropriate for the thread being used.	Select a needle that is appropriate for the type of stitch being used.	page 33
	The upper thread tension is too tight.	Loosen the upper thread tension.	page 54
	The thread is tangled, for example, in the shuttle.	Remove the tangle thread. If the thread is tangled in the shuttle, clean the shuttle.	page 135
	The needle is bent or blunt.	Replace the needle.	page 34
	The needle is incorrectly installed.	Correctly install the needle.	
	The area around the hole in the needle plate is scratched, or has a burr on it.	Replace the needle plate. Contact your retailer or the nearest authorized service center.	–
	The area around the hole in the presser foot is scratched, or has a burr on it.	Replace the presser foot. Contact your retailer or the nearest authorized service center.	–
	The shuttle is scratched, or has a burr on it.	Replace the shuttle. Contact your retailer or the nearest authorized service center.	–
	A bobbin designed specifically for this machine is not used.	Incorrect bobbins will not work properly. Only use a bobbin designed specifically for this machine.	page 18
<b>The lower thread is tangled or breaks.</b>	The bobbin thread is incorrectly installed.	Correctly install the bobbin thread.	page 22
	The bobbin is scratched or does not rotate smoothly, or has a burr on it.	Replace the bobbin.	–
	The thread is tangled.	Remove the tangled thread and clean the shuttle.	page 135
	A bobbin designed specifically for this machine is not used.	Incorrect bobbins will not work properly. Only use a bobbin designed specifically for this machine.	page 18
<b>The thread tension is incorrect.</b>	The upper thread was not threaded correctly.	Correct the upper threading.	page 24
	The bobbin thread is incorrectly installed.	Correctly install the bobbin thread.	page 22
	The combination of fabric, thread and needle is not correct.	Select a thread and needle that are appropriate for the type of fabric being sewn.	page 33
	The presser foot holder is incorrectly installed.	Correctly install the presser foot holder.	page 39
	The thread tension is incorrect.	Adjust the tension of the upper thread.	page 54
	A bobbin designed specifically for this machine is not used.	Incorrect bobbins will not work properly. Only use a bobbin designed specifically for this machine.	page 18





















Symptom	Probable Cause	Remedy	Reference
<b>The fabric is wrinkled.</b>	The upper thread was not threaded correctly, or the bobbin is incorrectly installed.	Correctly thread the upper thread and correctly install the bobbin thread.	page 22, 24
	The spool is incorrectly installed.	Correctly install the spool.	page 24
	The combination of fabric, thread and needle is not correct.	Select a thread and needle that are appropriate for the type of fabric being sewn.	page 33
	The needle is bent or blunt.	Replace the needle.	page 34
	If thin fabrics are being sewn, the stitch is too coarse.	Shorten the stitch length or sew with stabilizer material under the fabric.	page 56
	The thread tension is incorrect.	Adjust the tension of the upper thread.	page 54
<b>Stitches are skipped.</b>	The upper thread was not threaded correctly.	Correct the upper threading.	page 24
	The combination of fabric, thread and needle is not correct.	Select a thread and needle that are appropriate for the type of fabric being sewn.	page 33
	The needle is bent or blunt.	Replace the needle.	page 34
	The needle is incorrectly installed.	Correctly install the needle.	page 35
	Dust has accumulated under the needle plate or in the shuttle.	Remove the needle plate cover and clean the shuttle.	page 135
<b>A high-pitched noise is made while sewing.</b>	Dust has accumulated in the feed dogs or in the shuttle.	Clean the shuttle.	page 135
	The upper thread was not threaded correctly.	Correct the upper threading.	page 24
	The shuttle is scratched, or has a burr on it.	Replace the shuttle. Contact your retailer or the nearest authorized service center.	–
	A bobbin designed specifically for this machine is not used.	Incorrect bobbins will not work properly. Only use a bobbin designed specifically for this machine.	page 18
<b>The needle threader cannot be used.</b>	The needle was not raised.	Press the needle position button to raise the needle.	page 27
	The needle is incorrectly installed.	Correctly install the needle.	page 35
<b>The stitch is not sewn correctly.</b>	The presser foot that is used is not appropriate for the type of stitch that you wish to sew.	Attach the presser foot that is appropriate for the type of stitch that you wish to sew.	page 128
	The thread tension is incorrect.	Adjust the tension of the upper thread.	page 54
	The thread is tangled, for example, in the shuttle.	Remove the tangle thread. If the thread is tangled in the shuttle, clean the shuttle.	page 135

Symptom	Probable Cause	Remedy	Reference
<b>The fabric does not feed.</b>	The feed dogs are lowered.	Slide the drop feed lever to the left.	page 97
	The stitch is too fine.	Lengthen the stitch length.	page 56
	The presser foot that is used is not appropriate for the type of stitch that you wish to sew.	Attach the presser foot that is appropriate for the type of stitch that you wish to sew.	page 128
	The pressure of the presser foot is weak.	Turn the presser foot pressure dial to the right to increase the pressure of the presser foot.	page 39
	The thread is tangled, for example, in the shuttle.	Remove the tangle thread. If the thread is tangled in the shuttle, clean the shuttle.	page 135
<b>The sewing lamp does not come on.</b>	The sewing lamp is damaged.	Contact your retailer or the nearest authorized service center.	–
<b>Nothing appears in the LCD.</b>	The brightness of the LCD is either too light or too dark.	Adjust the brightness of the LCD.	page 142

## Error messages

If the start/stop button is pressed before the sewing machine is correctly set up or if an operation is performed incorrectly, an error message appears in the LCD. Follow the instructions that appear.

If you press  (OK key),  (back key) or do the operation correctly while the error message is displayed, the message disappears.

Error Message	Probable Cause
 The safety device has been activated.	The motor locked up because the thread is tangled.
 Lower presser foot lever.	The start/stop button, reverse/reinforcement stitch button or thread cutter button was pressed while the presser foot was raised.
 Return bobbin winding shaft to left.	The reverse/reinforcement stitch button, needle position button or thread cutter button was pressed while the bobbin winder shaft is moved to the right.
 Disconnect foot control.	The start/stop button was pressed while the foot controller was connected.
 Lift buttonhole lever.	A stitch other than the buttonhole, bar tack or darning stitch was selected and the start/stop button was pressed while the buttonhole lever is lowered.
 Lower buttonhole lever.	The buttonhole, bar tack or darning stitch was selected and the start/stop button was pressed while the buttonhole lever is raised.
 Select pattern.	The start/stop button or reverse/reinforcement stitch button was pressed after a stitch has been deleted.
Saving...	A pattern is being stored.
Winding bobbin thread.	The bobbin winder is winding the bobbin.
 No more stitches can be combined.	More than 71 patterns are being combined.
 Change speed controller mode to "OFF".	The start/stop button was pressed without connecting the foot controller while the setting for adjusting the stitch width using the sewing speed controller is set to [ON].
 Change to single needle mode.  → 	The twin needle setting is selected while a pattern that cannot be sewn with the twin needle is selected.
 Delete the selected pattern.  Cancel  Delete	The first pattern was selected while two or more patterns are combined.
 Can not change.	The selected setting cannot be changed with the selected pattern.

## Nothing appears in the LCD

If nothing appears in the LCD when the sewing machine is turned on, the brightness of the LCD is either too light or too dark. If this is the case, perform the following operation.

- 1 Turn off the sewing machine.

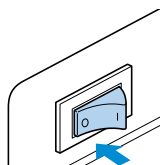

- 2 While pressing ↶ (back key) in the operation panel, turn on the sewing machine.
- 3 Press ◀ (-) or ▶ (+).  
Adjust the brightness of the LCD so that the screens can be seen.
- 4 Turn off the sewing machine, then turn it on again.

## Operation beep

Each time a key is pressed or an incorrect operation is performed, a beep is sounded.

- **For a correct operation**  
One beep is sounded.
- **If an incorrect operation is performed**  
Two or four beeps are sounded.
- **If the machine locks up, for example, because the thread is tangled**  
The sewing machine continues to beep for four seconds. The machine automatically stops. Be sure to check for the cause of the error, and correct it before continuing to sew.

## Cancelling the operation beep

When the sewing machine is purchased, it is set to beep each time an operation panel key is pressed. This setting can be changed so that the machine does not beep.

- 1 Turn on the sewing machine.

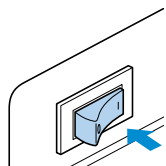

▶ The LCD comes on.

- 2 Press  (settings key) in the operation panel.

▶ The settings screen appears.

- 3 Press , ,  and  (arrow keys) until  is selected.



- 4 Press  (OK key).

▶ The screen for changing the beep setting appears.

- 5 Press  to select OFF.

To return to ON, press .

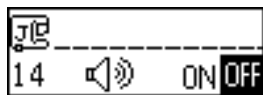

▶ The machine is now set so that it will not beep.

- 6 Press  (OK key).

▶ The initial stitch screen appears again.

## Removing the upper cover

If the upper cover of the sewing machine was removed, re-attach it as described in the following procedure.

- 1 Hold the upper cover level.

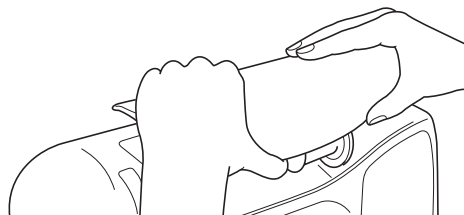

- 2 Push the upper cover down to re-attach it to the machine.

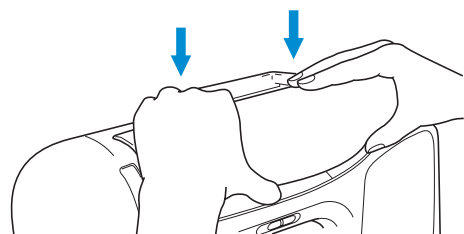

## Index

**Symbols**

+ key .....Cover E

**Numerics**

2-point zigzag stitch .....71  
3-point zigzag stitch .....71

**A**

accessories ..... Cover A  
adjustable zipper/piping foot .....89  
air vent ..... Cover C  
appliques .....93  
arrow keys .....Cover E  
automatic reinforcement stitching .....57  
automatic reverse stitching .....57  
automatic thread-cutting .....58

**B**

back key .....Cover E  
balance wheel .....Cover C, 48  
bar tack .....100  
baseline .....75  
basic stitching .....74  
blind hem stitch .....76  
bobbin .....Cover A, 22  
bobbin cover .....Cover C, 22  
bobbin thread .....22  
    pulling up .....31  
bobbin winder .....Cover B, 19  
bobbin winder seat .....20  
bobbin winder shaft spring .....19  
bobbin-winding .....18  
button sewing .....82  
buttonhole foot .....80  
buttonhole lever ..... Cover C, 80, 101, 103  
buttonhole stitching .....78

**C**

C key .....Cover E  
changing sewing direction .....62  
changing the needle .....35  
checking patterns .....116  
cleaning .....135  
cleaning brush .....Cover A, 136  
combining patterns .....114  
crazy quilt stitching .....95  
creating patterns .....123  
cross-stitch .....113  
cross-wound thread .....19  
curves .....62  
cylindrical pieces .....42

**D**

darning .....102  
designing patterns .....123

**E**

elastic tape .....91  
electrical outlet .....11  
error messages .....141  
even seam allowance .....64  
extra spool pin .....Cover A, 29  
eyelet .....104  
eyelet punch .....Cover A, 81, 104

**F**

fagoting .....106  
features .....2  
feed dog position switch .....Cover C, 98  
feed dogs .....Cover C, 97  
flipping .....119  
foot controller .....Cover A, 49  
foot controller jack ..... Cover C  
free-arm sewing .....42  
free-motion quilting .....97  
front view ..... Cover B

**H**

handle ..... Cover C  
hard case ..... Cover A  
heirloom stitching .....110

**J**

joining .....109  
joining stitch .....93

**K**

knee lifter .....Cover A, 61  
knee lifter mounting slot ..... Cover B

**L**

language .....17  
LCD ..... Cover E, 12, 142  
    brightness .....16, 142  
lower threading .....22

**M**

main power switch .....Cover C, 11  
maintenance .....135

**N**

needle	33
needle bar thread hook	Cover C, 26
needle clamp screw	35
needle plate	Cover C, 64
needle plate cover	135
needle position	55, 75
needle position button	Cover D
needle set	Cover A
needle stop position	16
needle threader lever	Cover B, 27
non stick foot	Cover A, 64

**O**

OK key	Cover E
openings	100
operating procedures	13
operation beep	142
operation buttons	Cover B, Cover D
operation manual	Cover A
operation panel	Cover B, Cover E
optional accessories	1
original patterns	123
overcasting stitches	70

**P**

patchwork stitching	95
pattern size	117
patterns	113
piecing	95
pocket corners	100
positioning fabric	48
presser foot	Cover C, 37
presser foot dial	Cover C, 39
presser foot holder	Cover C, 39
presser foot lever	Cover D
presser foot pressure	39
programmed thread-cutting	58

**Q**

quick reference guide	Cover A
quilting	96
quilting foot	Cover A, 97
quilting guide	1, 96, 97

**R**

realigning	121
rear view	Cover C
recalling a pattern	120
reinforcement stitching	51, 100
repeat sewing	115
reverse/reinforcement stitch button	Cover D

**S**

satin stitch	113
satin stitching	99
saving patterns	120

saving stitch settings	60
scallop stitching	107
screen language	17
screwdriver	Cover A, 35
seam ripper	Cover A, 81
selecting stitching	68
settings	14
settings key	Cover E, 14
sewing machine help key	Cover E, 13
sewing machine needles	33
sewing speed	49
sewing speed controller	Cover B, Cover D, 99
shell tuck stitch	108
shutter	26
shuttle	22, 135
shuttle hook	136
side cutter	1, 72
side view	Cover C
size	117
sleeves	100
smocking	107
spool cap	Cover A, 19, 25
spool net	Cover A, 31
spool pin	Cover B, 19, 25
start/stop button	Cover D, 49
starting sewing	49
stitch guide foot	Cover A, 64
stitch keys	Cover E
stitch length	56
stitch selection key	Cover E
stitch settings	128
stitch width	55
controlling	99
stitching density	118
storing patterns	Cover B, 120
straight stitch	74
stretch fabrics	64

**T**

thick fabrics	63
thin fabrics	64
thread cutter	Cover B, 53
thread cutter button	Cover D, 53
thread guide cover	Cover B, 20, 26
thread guide discs	Cover C, 27
thread guide for bobbin winding	Cover B, 20
thread guide plate	Cover B, 20, 26
thread tension	54
thread tension dial	Cover B, 54
thread that quickly unwinds	31
trial sewing	62
triple stretch stitch	100
troubleshooting	137
twin needle	Cover A, 28, 35

**U**

upper cover	Cover B, 19, 25
upper thread	24
upper thread tension	54

**W**

---

walking foot .....	Cover A, 40, 96
wide table .....	1, 42
wing needle .....	110

**Z**

---

zipper stitching .....	85, 89
------------------------	--------

CONTENTS

GETTING READY

SEWING BASICS

UTILITY STITCHES

APPENDIX

INDEX



